

PHILADELPHIA PA 19111
809 BERGEN ST
SAMUEL SACHS
ESS-2074 R IA 577 4

September, 1976 □ 75 cents

Electronic Servicing



A HOWARD W. SAMS PUBLICATION

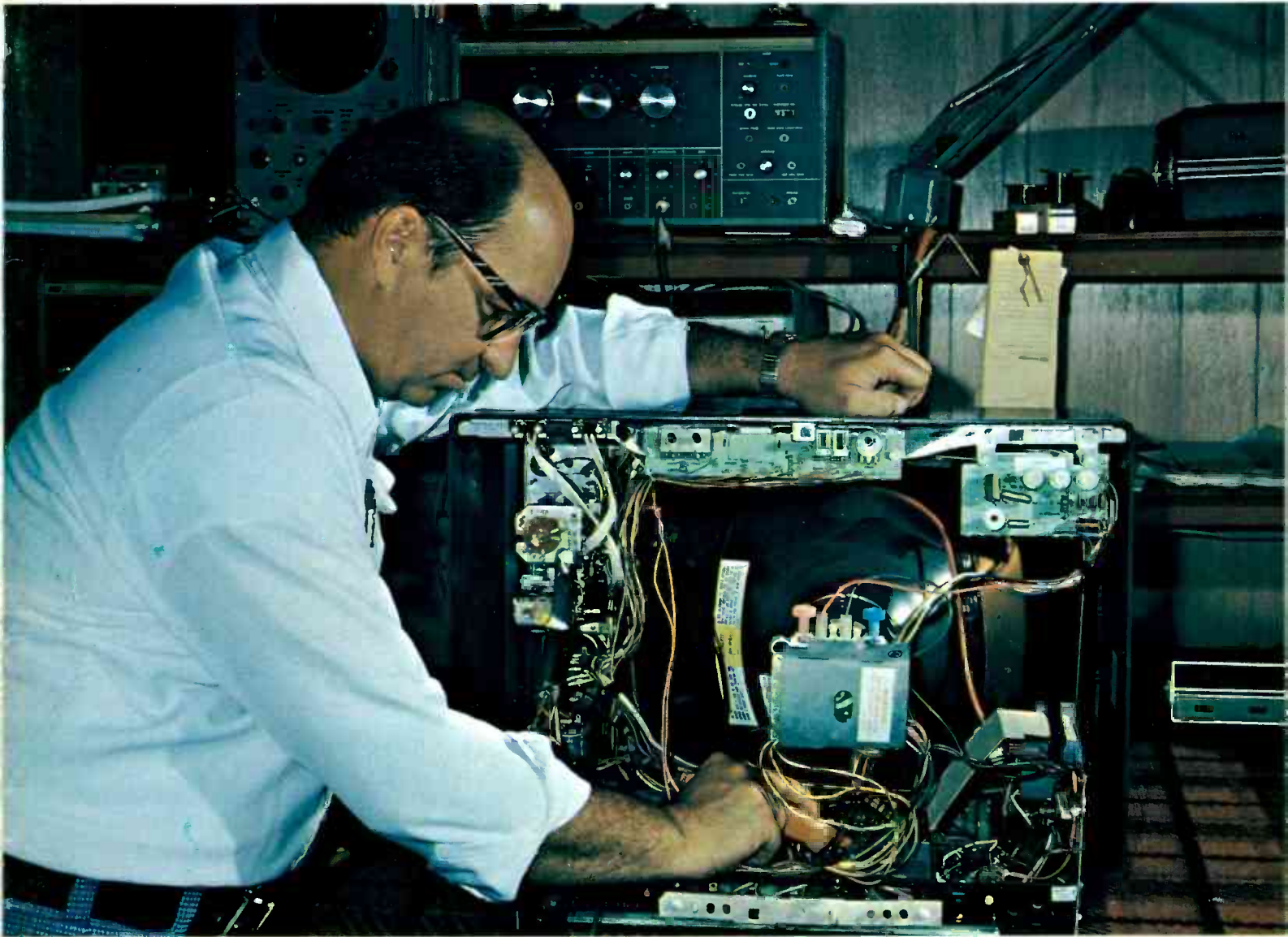

**PHILCO
CIRCUITS
AND
REPAIRS**

More
CB Measurements

GE Color Servicing

THE BEST OF EVERYTHING HAS ITS PRICE ...EVEN TUNER SERVICE!

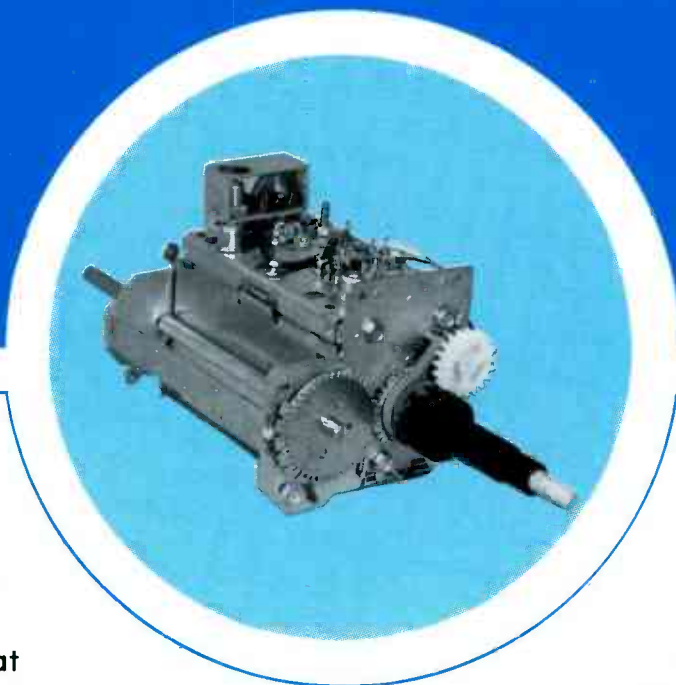

From the beginning, our goal has been to provide the best tuner service—never the cheapest. You get what you pay for in business and tuner service is no exception. The extra dollar you might pay at PTS is peanuts when you consider the added

reliability and the standards of excellence we apply to every job. Thousands of PTS customers must agree or we wouldn't be the world's largest tuner service company.

When you are comparing tuner service companies, price alone doesn't tell the story.

SAME DAY SERVICE • ORIGINAL PARTS • ONE YEAR WARRANTY

WE REPAIR THEM ALL . . . COLOR, BLACK & WHITE, TUBE,
TRANSISTOR OR VARACTOR . . . ANY MAKE OR MODEL.

VHF or UHF. . . \$10.95 UV-Comb. . . \$17.95

(MAJOR PARTS AND SHIPPING EXTRA — DEALER NET)



PTS ELECTRONICS, INC.

PRECISION TUNER SERVICE

General Headquarters: P.O. Box 272, Bloomington, IN 47401

THE COMPLETE LIST OF ALL PTS SERVICE CENTERS APPEARS ON THE NEXT PAGE.

For More Details Circle (1) on Reply Card

Electronic Servicing®

in this issue...

- 20 **Philco E21 Chassis...Circuits And Servicing, Part 1**—Chassis E20 and E21 are almost identical in both Philco and Sylvania brands. This first article takes up the power supply and the shut-down circuit that gives perplexing symptoms when the voltage is excessive—*John Simrell.*
- 28 **CB Test Readings...Right Or Wrong?, Part 2**—Can you imagine a length of coax acting as a short at a certain frequency? That's just one of the traps to avoid with CB radio repairs—*Marvin J. Beasley, CET.*
- 32 **Making A "Clean" Sale**—If we had rich customers, such as this one, perhaps we too could have amusing adventures—*Shelby Henle.*
- 34 **Servicing GE Modular Color, Part 2**—A complete analysis is made of the low-voltage power supplies and the regulators of the GE 19YC2 chassis—*Gill Grieshaber, CET.*
- 40 **Servicing Electronic Organs, Part 4**—Troubleshooting tests are given for defects that can cause a single organ note to be wrong—*Norman H. Crowhurst.*
- 45 **Lotsa Short Circuits**—Work this Pinwheel Puzzle that has the electronic words going in a circle—*Edmund A. Braun.*
- 46 **Reports From The Test Lab**—Features and performances of two Simpson color-bar generators are spotlighted—*Carl Babcoke.*

ABOUT THE COVER

John Simrell heats a transistor while testing a Philco E21 chassis at Wilson Distributing, where he is service manager.

DEPARTMENTS

| | |
|----------------------------------|------------------------------------|
| Electronic Scanner 4 | Product Report 55 |
| Symcure 8 | Book Review 57 |
| Troubleshooting Tips 9 | Catalogs and Literature 58 |
| Reader's Exchange 12 | Photofact 59 |
| Test Equipment 53 | Advertiser's Index 60 |

Second class postage paid at Shawnee Mission, Kansas and additional mailing offices. Published monthly at 9221 Quivira Road, Overland Park, Kansas 66212 by Intertec Publishing Corp., 9221 Quivira Road, Overland Park, Kansas 66212. Send Form 3579 to 9221 Quivira Road, P.O. Box 12901, Overland Park, Kansas 66212.

© Copyright, 1976, Howard W. Sams & Co., Inc. All rights reserved. Material may not be reproduced or photocopied in any form without written permission of publisher.

**YOU'VE GOT US
WHERE YOU
WANT US!**

THE WORLD'S LARGEST
TUNER SERVICE
IS CLOSE TO YOU!

- | | |
|--|---|
| <p>MIDWEST Home Office BLOOMINGTON, IN 47401 5233 S. Hwy. 37, P.O. 272 812-824-9331 CLEVELAND, OH 44134 5692 State Road 216-845-4480 KANSAS CITY, KS 66106 3116 Merriam Lane 913-831-1222 MINNEAPOLIS, MN 55408 815 W. Lake St., P.O. 8458 612-824-2333 ST. LOUIS, MO 63130 8456 Page Blvd., P.O. 24256 314-428-1299 DETROIT, MI 48235 13709 W. 8-Mile Rd. 313-862-1783 GRAND RAPIDS, MI 49501 1134 Walker Northwest P.O. 1435 616-454-2754 CINCINNATI, OH 45215 8180 Vine St., P.O. 15491 413-821-2298 MILWAUKEE, WI 53215 3509 W. National 414-643-8800 COLUMBUS, OH 43227 4005A E. Livingston 614-237-3820 INDIANAPOLIS, IN 46202 28 E. 14th St. 317-631-1551 DAVENPORT, IA 52805 2024 E. River Dr., P.O. 187 919-323-3975</p> | <p>SOUTH JACKSONVILLE, FL 32210 1918 Blanding Blvd., P.O. 7923 904-389-9952 WASHINGTON, DC Silver Spring, MD 20910 8880 Brookville Rd. 301-565-0025 CHARLOTTE, NC 28205 724 Seigle Ave., P.O. 5512 804-332-8007 BIRMINGHAM, AL 35222 524-32nd St. S., P.O. 31004 205-323-2657 MEMPHIS, TN 38118 3614 Lamar Ave., P.O. 18053 901-365-1918 NORFOLK, VA 23504 3118 E. Princess Anne Rd. 804-625-2030 NEW ORLEANS Metairie, LA 70004 3920A Airline Hwy., P.O. 303 TAMPA, FL 33690 2703 S. Macdell, P.O. 14301 813-839-5521 NASHVILLE, TN 37214 2426 A Lebanon Rd. 615-885-0688</p> |
| <p>NORTHEAST SPRINGFIELD, MA 01103 191 Chestnut, P.O. 3189 413-734-2737 PHILADELPHIA Upper Darby, PA 19082 1742-44 State Road, P.O. 207 215-352-6609 PITTSBURGH, PA 15202 257 Riverview Ave., P.O. 4130 412-761-7648 E. PATERSON, NJ 07407 158 Market St., P.O. 357 201-791-6380 BUFFALO, NY 14212 993 Sycamore St., P.O. 1241 716-891-4935 BOSTON Somerville, MA 02144 52 Holland St., Davis Sq. 617-666-4770 SYRACUSE, NY 13204 418 Solar St. 315-475-2330</p> | <p>PACIFIC SACRAMENTO, CA 95841 4611 Auburn Blvd., P.O. 41354 916-482-6220 SAN DIEGO, CA 92105 5111 University Ave., P.O. 5794 714-280-7070 LOS ANGELES, CA 90023 4184 Pacific Way 213-266-3728 PORTLAND, OR 97213 5220 N.E. Sandy Blvd. P.O. 13096 503-282-9636 SEATTLE, WA 98109 432 Yale Ave., P.O. 9225 206-623-2320</p> |
| <p>SOUTHWEST LONGVIEW, TX 75601 Mopac Rd., P.O. 7332 214-753-4334 OKLAHOMA CITY, OK 73106 3007 No. Pay, P.O. 60566 405-947-2013 HOUSTON, TX 77207 4326 Telephone Rd., P.O. 26616 713-644-6792</p> | <p>MOUNTAIN DENVER Arvado, CO 80001 4958 Allison St., P.O. 672 303-423-7080 SALT LAKE CITY, UT 84106 1233 Wilmington Ave. P.O. 6218 801-466-1451 PHOENIX, AZ 85061 2412 W. Indian School Rd. P.O. 27248 602-266-0582 CANADA MONTREAL, P/Q 8400 St. Lawrence Blvd. Room 205 514-381-4233</p> |



PTS ELECTRONICS, INC.
PRECISION TUNER SERVICE

For More Details Circle (24) on Reply Card

Money Generator

PAT. PEND.

\$299.95



ATC-10 GENERAL TELEVISION SERVICER

- Extra wide range RF/IF attenuator for testing receiver sensitivity.
- **HATCHDOTS** - versatile composite pattern for dynamic & static convergence plus other checks.
- **COLOR BARS** pattern with 6th bar marked to make your job easier.
- **3.58 MONITOR** pattern for oscillator frequency checks with no need to short the AFPC test point.
- **RED RASTER** pattern for checking and adjusting purity at the flip of a switch.
- High level, 75 ohm output provided.
- ◆ 2 year factory warranty.
- ◆ 30 day money back guarantee.
- ◆ 2 volume owner's manual available separately - \$1.00.

Unique

One of the most useful, **UNIQUE** patterns of the ATC-10 is the **GRAY QUAD** pattern below. Use it for checking and adjusting gray scale tracking or for checking effects of video level upon horizontal sync. Use it to check for reversed yoke connections - vertical, horizontal or both. Use it to check low frequency video response. *It can save you time, trouble and money!* Write us.

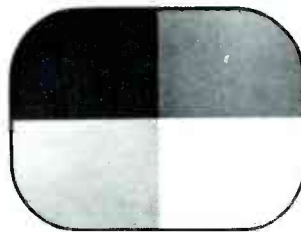

American Technology Corporation

225 Main Street, Dept. 9A, Canon City, Colorado 81212

Credit card & COD phone orders accepted. Same day shipment. (303) 275-8991, ext. 1.

For More Details Circle (25) on Reply Card

The "New Generation" Flat-Rate Pricing...

is proving itself in thousands of shops from coast to coast—it prices your work profitably while creating customer good-will.

Fast tab indexing to 19 major repair categories prices all bench, home and over-the-counter repairs with authority.

tv & radio tech's guide to pricing

Plus, Computerized Pocket-Size Parts Catalog.

Customized to your desired parts profit. Lists over 3500 most-used parts, continually up-dated. Can easily recover initial investment in less than 30 days... \$75.00 plus \$10.00 per catalog.



Satellite Edition...
the same system described above, only reduced to shirt-pocket size for outside service...
\$16.95 ea. post pd.
Quantity prices available.

Professional
6 x 9 hard cover,
steel ring-bound
edition....
\$19.95 ea. post pd.



P.O. Box 5234
Lincoln, NE 68505
sperry tech inc.

____ copies, Hardbound. ____ copies, Satellite
____ copies, Parts Catalog. More information
Amount enclosed, check or money order.
(NE res. add sales tax)

NAME _____
CO. _____
ADDRESS _____
CITY _____
STATE _____ ZIP _____

For More Details Circle (26) on Reply Card

Electronic Servicing

Editorial, advertising and circulation correspondence should be addressed to: 9221 Quivira Road, P.O. Box 12901, Overland Park, Kansas 66212 (a suburb of Kansas City, Missouri). (913) 888-4664

EDITORIAL

RONALD N. MERRELL, Director
CARL H. BABCOKE, Editor
SHARON ELWOOD, Editorial Assistant
DUDLEY ROSE, Graphic Designer

EDITORIAL ADVISORY BOARD

LES NELSON, Chairman
Howard W. Sams & Co., Indianapolis
JOE A. GROVES, Technical Consultant
Howard W. Sams & Co., Indianapolis

CIRCULATION

GREG GARRISON, Director
EVELYN ROGERS, Manager

ADVERTISING SALES

Overland Park, Kansas 66212
(a suburb of Kansas City, Missouri)
Tele: (913) 888-4664

MIKE KREITER, Director

GLORIA PARMENTER, Production

REGIONAL ADVERTISING SALES OFFICES

Indianapolis, Indiana 46280
ROY HENRY
2469 E. 98th St.
Tele: (317) 846-7026

Greenlawn, New York 11740
CHARLES C. HORNER
P.O. Box 175
Tele: (516) 757-8868

Mountain View, California 94043
DENNIS TRIOLA
2680 Bayshore Frontage Road, Room 102
Tele: (415) 961-0378

London W.C. 2, England
JOHN ASHCRAFT & CO.
12 Bear Street
Leicester Square
Tele: 930-0525

Badhoevedorp, Holland
John Ashcraft & Co.,
John J. Lucassen, Mgr.
Sloterweg 303
Tele: 2968-6226

Tokyo, Japan
INTERNATIONAL MEDIA
REPRESENTATIVES LTD.
1, Shiba-Kotohiracho, Minatoku
Tele: 502-0656



Member, American Business Press
Member, Audit Bureau of Circulations

ELECTRONIC SERVICING (with which is combined PF Reporter) is published monthly by Intertec Publishing Corp., 9221 Quivira Road, Overland Park, KS 66212.

ELECTRONIC SERVICING is edited for technicians who repair home-entertainment electronic equipment (such as TV, radio, tape, stereo, and record player), and for industrial technicians who repair defective production-line merchandise, test equipment, or industrial controls in factories.

Subscription Prices: 1 year—\$6.00, 2 years—\$10.00, 3 years—\$13.00, in the U.S.A. and its possessions. All other foreign countries: 1 year—\$7.00, 2 years—\$12.00, 3 years—\$16.00. Single copy 75 cents; back copies \$1. Adjustment necessitated by subscription termination to single copy rate. Allow 4-6 weeks delivery for change of address. Allow 2-3 weeks for new subscriptions.



Robert E. Hertel, Publisher
INTERTEC PUBLISHING CORP.
Subsidiary of HOWARD W. SAMS & CO., INC.

STACK UP PROFITS WITH THESE NEW HEATH AUDIO SERVICE INSTRUMENTS!



NEW!
ONLY
\$250⁰⁰

Factory tested and calibrated.

An IM distortion analyzer that's designed for professional audio servicing. The lowest range, 0-0.1% (readable to 0.01%) with 5% full scale accuracy gives you all the readability and accuracy you need for testing the most modern audio equipment.

Conformance to both SMPTE and IEEE standards is insured by use of internal 60 Hz and 7 kHz oscillator outputs. Rear panel jacks allow use of external generators for other standards. Built-in AC voltmeter with a dB scale adds even more convenience to the unit. Universal five-way binding posts let you use the analyzer with virtually all associated equipment—without special cables or adapters.

Features, range and accuracy at an incredibly low cost. The Heath/Schlumberger SM-5248 Intermodulation Distortion Analyzer shows you the way to put audio service profit on your service bench.

Factory tested and calibrated Only \$250.00

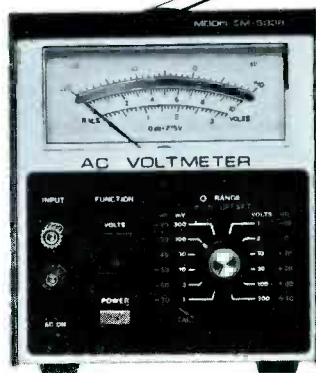

NEW!
ONLY
\$130⁰⁰

Factory tested and calibrated.

The superb Heath/Schlumberger SM-5238 AC Voltmeter is the first to offer both a 3-decade linear dB scale and linear voltage scales. Not the familiar log function scales found on other voltmeters. Easier measurements mean less time and more profit.

Twelve voltage ranges, from 0-1 mV to 0-300 VAC, with an accuracy of 4% of full scale, provide all the meter capability you'll ever require. dB measurements can be made from -70 to +40 dB over twelve ranges in 10 dB increments with an accuracy of ±0.5 dB. The measurable frequency range is 10 Hz to 1 MHz ±1 dB. This is the AC Voltmeter for your service bench.

If you ever have had to measure low level signals, such as ripple or noise in a power supply, the SM-5238 now gives you the scale legibility you want from a meter.

Rear panel amplifier output and DC outputs proportional to meter reading for direct recorder connection enhance the unit's versatility. Now is the time to add the SM-5238 to your service equipment inventory.

Factory tested and calibrated Only \$130.00



NEW!
ONLY
\$330⁰⁰

Factory tested and calibrated.

A harmonic distortion analyzer with auto-null for less than \$1000! Simply "rough-tune" the analyzer and flip the AUTO mode switch. The analyzer automatically balances, eliminating the need for delicate and time consuming fine-tune adjustments. Service dollars move off your bench in less time.

Harmonic distortion measurements as low as 0.03% can be made on the 0-0.3% range over a frequency range of 5 Hz to 100 kHz allowing you to check and service amplifiers and receivers claiming the finest specifications. Residual distortion is less than 0.03% and the meter is accurate to within 5% of full scale over five ranges. A built-in AC Voltmeter with full scale ranges from 1 mV to 300 VAC makes your THD measurements move even faster.

A perfect companion instrument to the SM-5248, the Heath/Schlumberger SM-5258 is a superb quality, low-cost addition to your audio service bench!

Factory tested and calibrated Only \$330.00

Order your profit makers now!

For exactly the range, accuracy, versatility and dependability you need to make your audio service profits grow, order all three superb Heath/Schlumberger audio service instruments today!

Heath Co., Dept. 25-21,
Benton Harbor, MI 49022

HEATH
Schlumberger

Heath Company, Dept. 25-21
Benton Harbor, Michigan 49022

Gentlemen, please send me:

- SM-5248 IMD Analyzer at \$250.00 (add \$2.75 for shipping and handling)
- SM-5258 THD Analyzer at \$330.00 (add \$3.00 for shipping and handling)
- SM-5238 AC Voltmeter at \$130.00 (add \$1.75 for shipping and handling)

Michigan residents add 4% sales tax.

I enclose a check money order for \$ _____; or, charge to my:

BankAmericard Acct. No. _____ Exp. Date _____

Master Charge Acct. No. _____ Exp. Date _____

If Master Charge, Include Code No. _____

Signature: X _____

Name: (please print) _____

Address _____

City _____ State _____ Zip _____

TE-337 Prices and specifications subject to change without notice.

electronicsscanner

news of the industry

General Electric has announced that it will not adopt the recently-introduced Zenith picture tube design. "It was concluded that no benefit in perceived picture quality would be obtained by such a shift," said Fred R. Wellner, general manager of GE's Television Business Department. "Further, the costs of tooling, cabinet redesign, and chassis modification needed to convert to the Zenith system were not offset by long term promises for lower glass costs."

Dynascan Corporation reports record sales and earnings for the second quarter and six months ended June 30th, aided by strong sales of Cobra Citizens Band radios, and increased volume of industrial products. It was the sixth consecutive quarter in which Dynascan's earnings more than doubled the year-ago figures.

The first large-scale sale of Blonder-Tongue pay-cable TV decoders has been made to Central N.Y. Cable TV of Utica, New York, by Toner Cable Equipment. The initial sale was for 5000 B-T pay-cable decoders plus a headend encoder. The decoders are being used to provide Home Box Office programs to subscribers in the Utica service area. The B-T decoder is said to be the only unit that provides scrambling of both picture and sound. Sound from R- or X-rated films or similar programming will not be heard by non-subscribers or by subscribers who do not wish to receive it. The new decoders are sold only directly to cable-TV operators.

RCA recently confirmed reports that the firm would make and market a "high-end" TV video game before the end of the year. The game will use a C/MOS 1802 microprocessor supplied by the RCA Solid State Division, according to *Electronic News*, and will be distributed through the RCA Distributing Corporation of Indianapolis.

A wide variety of explosives can be detected in seconds with the portable explosives detectors designed and manufactured by Leigh Instruments of Waterloo, Ontario. The detectors can detect a hidden bomb from a distance, across a room, or in a ventilation air stream. The instruments also can detect (even days later) whether or not a vehicle was used to transport explosives. They operate by sensing the vapors from explosives. Leigh's detectors are available in two basic forms: one walk-through model resembles the weapon-metal detectors now used at most airports; the other is similar in appearance to a Geiger counter.

The citizens-radio band (CB) has been expanded by the FCC from 23 channels to 40, effective January 1, 1977. The 17 new channels will occupy frequencies between 27.230 MHz and 27.410 MHz, now allocated to land-mobile communications. At the same time, the FCC established new technical standards, such as: "second and higher-order harmonic radiation must be suppressed by at least 60 dB for all transmitters type accepted." Also, to combat the high incidence of radio thefts, the FCC requires the serial numbers to be stamped (indented) on the chassis. Other FCC rules are attempting to discourage the manufacturers from modifying radios (which already have been sold) to tune the new frequencies. Some manufacturers interpret the rules differently, and say they will offer both before-sale and after-sale modification.

(Continued on page 6)

Now you can order GE TV parts over the phone, toll-free*, and charge them to your credit cards.



Now simply call in your GE TV part order toll-free* and charge it to your Master Charge or BankAmericard account (give number and expiration date on the phone). Your order can be processed immediately.

This new arrangement eliminates costly COD charges, time-consuming credit checks or having to send cash with an order. This easy order procedure is just one more example of General Electric's on-going dedication to making your business easier.

*TOLL FREE TELEPHONES NOW AVAILABLE IN MOST STATES.

Send in this coupon for the handy brochure covering GE's toll-free phone numbers and other support programs.

We're making it our business to make your business easier.

"DUTCH" MEYER
GENERAL ELECTRIC COMPANY
TELEVISION BUSINESS DEPARTMENT
COLLEGE BOULEVARD
PORTSMOUTH, VA. 23705

Please send me the brochure covering GE's toll-free phone numbers and other support programs.

NAME _____
SERVICE COMPANY _____
ADDRESS _____
CITY _____
STATE _____
ZIP _____

 **performance**
TELEVISION

GENERAL  ELECTRIC

(Continued from page 4)

Jane Byrne, head of Chicago's Department of Consumer Sales, is recommending a Chicago TV-service licensing bill because of a rising number of consumer TV servicing complaints. Mrs. Byrne said her office received 120 complaints of television repair irregularities last year and has received 81 so far this year. One practice cited was needlessly taking a customer's set to the shop when it could be repaired in the home. Frank J. Moch, executive director of the National Alliance of Television and Electronics Service Associations (NATESA), said his organization would oppose city licensing, claiming that state licensing is needed and has been backed by his group.

Notice anything different about this issue of ELECTRONIC SERVICING? The magazines now are printed in Kansas City on Intertec's new presses, rather than by the Howard W. Sams facilities in Indianapolis. Several changes were necessary. Dimensions of the pages are different, but only by a fraction of an inch. Most noticeable is the change from the "perfect", or book-type binding, to "saddle-stitching", which holds the pages by two metal staples. It's not possible now to include on the "spine" any information about the year and month. Instead a small black line will be placed at a different height each month. When the magazines are placed in order on a shelf, the lines will form a kind of staircase. Also, several months ago, we changed the circulation and Reader's Service cards, and included up-to-date addresses to be used when you write about different subjects. Please notice that only Howard W. Sams (not Electronic Servicing) has books and Photo-facts for sale.

Satellite TV came to Kansas City with the Republican National Convention in August. The 30-foot dish, a part of the Westar satellite system of Western Union, was crowded between the 23rd Street Viaduct and some railroad tracks just a few hundred feet from Kemper Arena. It was not necessary to place the antenna on a hill. What difference could a few more feet make to a signal going 22,000 miles to a satellite? Then from the Westar satellite, the signal was beamed to a receiving station in New Jersey, from where it was relayed to the various network facilities in New York City.



Tuner Service Corporation

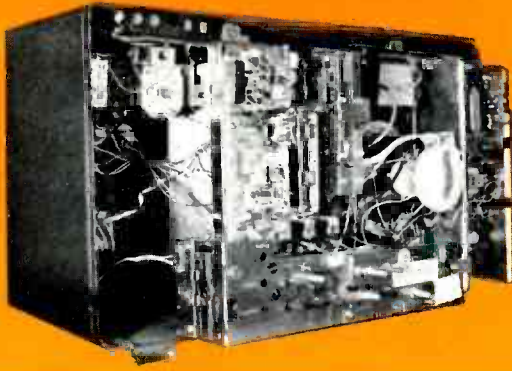

STILL ONLY
\$995
 U.S.A. ONLY

Major Parts and Shipping Charged at Cost

One Year Guarantee

MODULE REPAIRS

TSC has been repairing private brand TV modules for over 2 years.

Expanded facilities now include modules for

- RCA
- GE
- ZENITH
- W. T. GRANT
- J. C. PENNEY
- WESTERN AUTO
- GAMBLES

as well as Zenith IF subchassis.

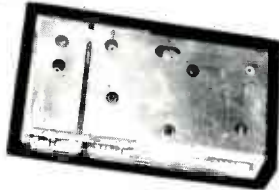
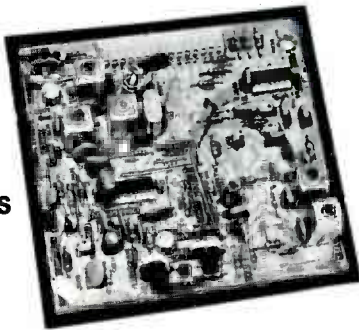

For free Price List and complete information write or phone; TSC HEADQUARTERS, BLOOMINGTON, IND. or any of the TSC locations listed below.

PROVIDES YOU WITH A COMPLETE SERVICE FOR ALL YOUR TELEVISION TUNER REQUIREMENTS.

REPAIR

VHF OR UHF ANY TYPE (U.S.A. ONLY) \$ 9.95
 UHF/VHF COMBINATION (U.S.A. ONLY) \$15.00

MAJOR PARTS AND SHIPPING CHARGED AT COST.

- Fast, efficient service at our conveniently located Service Centers.
- All tuners are ultrasonically cleaned, repaired, realigned, and air tested.

REPLACE

UNIVERSAL REPLACEMENT TUNER \$12.95 (U.S.A. ONLY)

- This price buys you a complete new tuner built specifically by Sarkes Tarzian Inc. for this purpose.
- All shafts have a maximum length of 10½" which can be cut to 1½".
- Specify heater type parallel and series 450 mA. or 600 mA.

CUSTOMIZE

- Customized tuners are available at a cost of only \$15.95. With trade-in \$13.95. (U.S.A. ONLY)
- Send in your original tuner for comparison purposes to any of the Centers listed below.

SAME DAY SERVICE — ONLY ORIGINAL FACTORY PARTS USED



WATCH US GROW

| | | | |
|---------------|-------------------------------|-------------------------------------|-------------------|
| HEADQUARTERS | BLOOMINGTON, INDIANA 47401 | 537 South Walnut Street | Tel. 812-334-0411 |
| ARIZONA | TUCSON, ARIZONA 85713 | 1528 S. 6th Ave. | Tel. 602-791-9243 |
| CALIFORNIA | NORTH HOLLYWOOD, CALIF. 91601 | 10654 Magnolia Boulevard | Tel. 213-769-2720 |
| | SAN MATEO, CALIF. 94402 | 600 S. Amthlett Blvd. | Tel. 415-348-3292 |
| | MODESTO, CALIF. 95351 | 123 Phoenix Avenue | Tel. 209-521-8051 |
| FLORIDA | TAMPA, FLORIDA 33606 | 1505 Cypress Street | Tel. 813-253-0324 |
| | FT. LAUDERDALE, FLORIDA 33315 | 104 S.W. 23rd St., Bay 76 | Tel. 305-524-0914 |
| GEORGIA | ATLANTA, GA. 30310 | 846 Evans St. S.W. | Tel. 404-758-2232 |
| ILLINOIS | CHAMPAIGN, ILLINOIS 61820 | 405 East University Street | Tel. 217-356-6400 |
| | BOLTON, ILL. 60419 | 1507-09 E. 142nd St. | Tel. 312-841-4444 |
| | SKOKIE, ILLINOIS 60076 | 5110 West Brown Street | Tel. 312-675-0230 |
| INDIANA | INDIANAPOLIS, INDIANA 46204 | 112 West St. Clair Street | Tel. 317-632-3493 |
| IOWA | DES MOINES, IOWA 50319 | 5005 Douglas St. #5E | Tel. 515-278-4217 |
| KENTUCKY | LOUISVILLE, KENTUCKY 40205 | 2244 Taylorsville Road | Tel. 502-452-1191 |
| LOUISIANA | SHREVEPORT, LOUISIANA 71104 | 3025 Highland Avenue | Tel. 318-221-3027 |
| MARYLAND | BALTIMORE, MARYLAND 21215 | 5505 Reisterslawn Rd., Box 2624 | Tel. 301-358-1186 |
| MASSACHUSETTS | SPRINGFIELD, MASS. 01108 | 405 Dickinson St. | Tel. 413-788-8206 |
| MISSOURI | ST. LOUIS, MISSOURI 63132 | 9577 Page Avenue | Tel. 314-429-0633 |
| NEVADA | LAS VEGAS, NEVADA 89102 | 1412 Western Avenue No. | Tel. 702-384-4235 |
| NEW JERSEY | TRENTON, NEW JERSEY 08638 | 1139 Pennsylvania Ave. | Tel. 609-393-0999 |
| | NEW JERSEY 07307 | 547-49 Tonnele Ave., Hwy. 1 & 9 | Tel. 201-792-3730 |
| NEW YORK | ROCHESTER, NEW YORK 14615 | 37 Pullman Ave. | Tel. 716-647-9180 |
| N. CAROLINA | GREENSBORO, N.C. 27405 | 2914 E. Market Street | Tel. 919-273-6276 |
| OHIO | CINCINNATI, OHIO 45216 | 7450 Vine Street | Tel. 513-821-5080 |
| | CLEVELAND, OHIO 44108 | 4525 Pearl Road | Tel. 216-741-2314 |
| OREGON | PORTLAND, OREGON 97210 | 1732 N.W. 25th Ave., P.O. Box 10141 | Tel. 503-222-9059 |
| PENNSYLVANIA | PITTSBURGH, PA. 15209 | 515 Grant Avenue | Tel. 412-821-4004 |
| TENNESSEE | MEMPHIS, TENNESSEE 38111 | 3158 Barron Avenue | Tel. 901-458-2355 |
| TEXAS | DALLAS, TEXAS 75218 | 11540 Garland Road | Tel. 214-327-8413 |
| VIRGINIA | NORFOLK, VIRGINIA 23513 | 329 Santos Street | Tel. 804-855-2518 |
| CANADA | ST. LAURENT, QUEBEC H4N-2L7 | 305 Decarie Boulevard | Tel. 514-748-8803 |
| | CALGARY, ALBERTA T2H-0L1 | P.O. Box 5823, Stn. "A" | Tel. 403-243-0971 |

For More Details Circle (11) on Reply Card

25 Invitations to great reception.

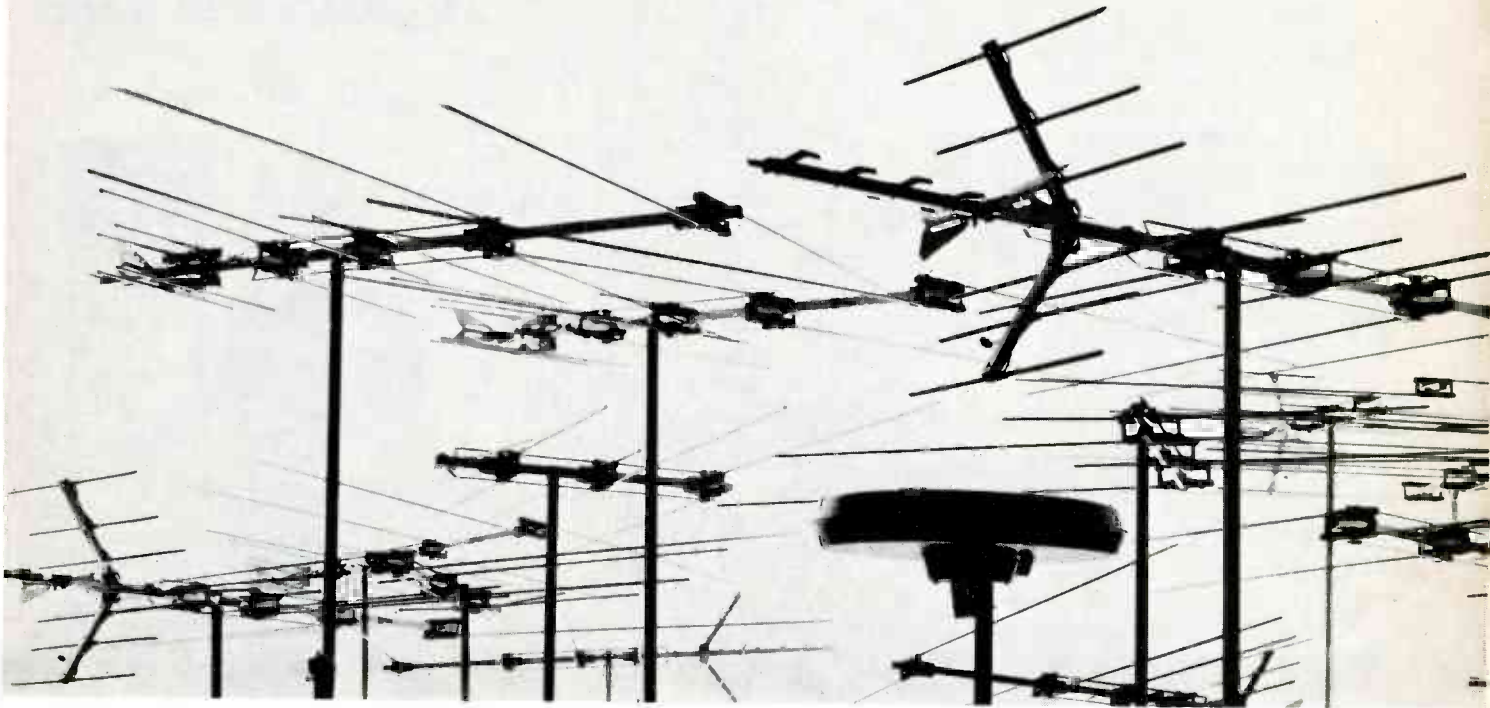

Help!

Anytime you have a question about your subscription to *Electronic Servicing*, please include a mailing label to insure prompt service on your inquiry.

Change of Address

If you're about to move, please let us know approximately four weeks before the move comes about. Simply affix your present label here, and carefully print the updated information below.

AFFIX LABEL HERE

Please Help Us to Serve You Better

Electronic Servicing
1014 Wyandotte Street
Kansas City, Mo. 64105

Name _____

(Please Print)

Employer _____

Address _____

City _____ State _____ Zip _____

(Continued from page 9)

sprayed each transistor in turn with coolant. When Q11 (first stage) was sprayed, the noise and the gain returned.

I replaced Q11 with an approved substitute, and was happy to find that the audio was noise-free and normal.

However, I wondered what the defect was, and checked Q11 using an expensive transistor tester. To my surprise, the gain was good, and no leakage or other defects were found. Evidently the noise was not excessive until it was amplified by the following stages.

Ronald Bobo, CET
Hillsboro, Missouri

Wrong hues of color

RCA CTC43 (Photofact 1137-1)

After making a factory modification to prevent short life of the damper diode, I noticed the hues of the picture were green and purple only. The A1 encapsulated-component demodulator was replaced on suspicion, but the color remained weak and the hues were wrong.

A scope check at the inputs to the demodulator indicated the color signal was weak. DC voltages of V4A (second chroma bandpass amp) revealed an abnormal cathode voltage of about +40. I found a bad solder joint at one end of the cathode resistor, R25. Now, the color was stronger, but the hues were still wrong.

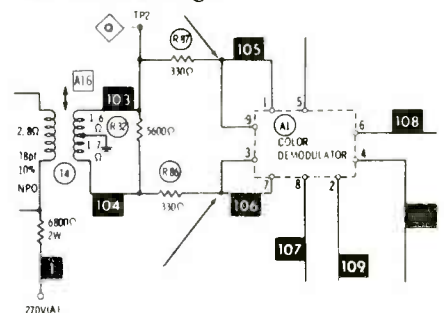

Defects in the ACC and killer circuits sometimes produce some odd symptoms, so I checked there. Sure enough, the killer could not be made to develop -23 volts, and the collector of the ACC transistor was far from the usual +75 volts. Both transistors checked normal.

Negative voltage is obtained from

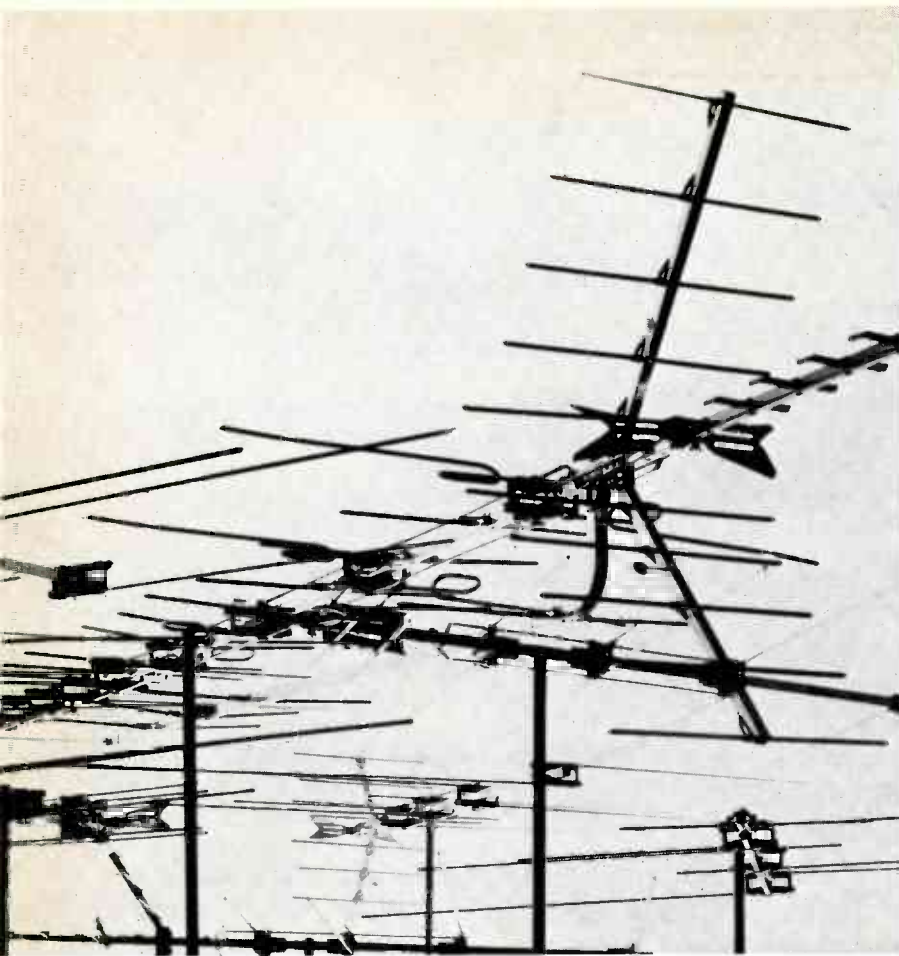

Outdoor antennas, for sure. For UHF, VHF and FM — and almost any combination. Plus Mini-State — RCA's newest and most advanced miniature rotating antenna for the best possible reception in apartments, homes, boats, trailers and RVs.

We don't stop there, either. Our line of great rotators for outdoor antennas, our reception aid amplifiers, splitters, transformers, and our easy-as-pie mounting hardware, give you the most complete line of invitations for great reception anywhere.

RSVP. For all the details, see your RCA Distributor — or contact RCA Distributor and Special Products Division, Cherry Hill, N.J. 08101.

RCA Permacolor
Outdoor Antennas

the grid circuit of the horizontal-blanker tube, and the voltages there

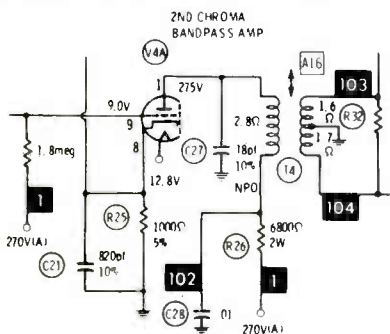

were completely wrong. The grid had too much pulse amplitude and zero DC. A new 6GH8A blanker tube restored the voltages there and gave normal killer and ACC operation. **But the hues were still wrong!**

At this point, I took time to review all the steps. Also, the installation of a new demodulator unit had not helped, so I re-installed the original part. **Presto**—the color now was fine, including all hues.

The **new** demodulator was defective, but the blanker trouble had

obscured the symptoms so it appeared the demodulator replacement had made no difference. I

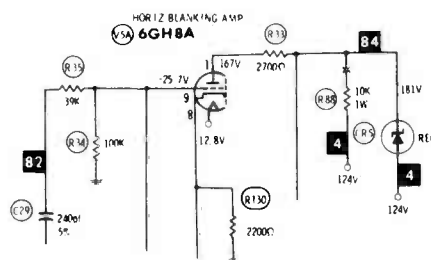

learned this lesson: use the scope **before** you start replacing parts!

Ray Russell
Harry's TV
Bear Lake, Michigan

No raster; red horizontal tube Zenith 16Z7C19
(Photofact 1014-3)

The sound came on okay, but there was no raster. Then the plates of the horizontal output and damper tubes began to glow red. These symptoms usually indicate a loss of horizontal-oscillator drive at the grid of the output tube. A scope

check proved the oscillator signal was missing.

Before I do very many instrument tests, I give the suspected circuit a good "eyeball" examination. In this case, it paid off, for I noticed that R238 appeared slightly burned.

After it was disconnected and measured, R238 was found to be more than double in resistance.

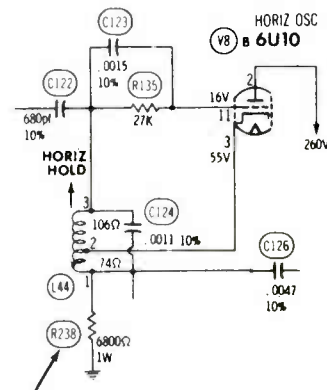

Evidently, the wrong value had stopped the oscillator, because replacing the resistor restored normal operation.

R. L. Osborn
Wichita, Kansas

reader's exchange

Needed: Schematic or manual for Philco radio, Model 41-844.

W. S. Opalach
201 West California Avenue
Apartment #105
Sunnyvale, California 94086

Needed: Power transformer, number 54-26, for a Heathkit lab scope, Model 0-12.

Albert Roth
104 Springfield Road
Clifton Heights, Pennsylvania 19018

Needed: Schematic for a Globe Star 300, Model 65-1831T CB set. Will buy, or copy and return.

Clarence F. Kuschel
RR 2, Box 119A
Birnamwood, Wisconsin 54414

Needed: 1 selector switch, 2 section, 6 position, rotary wafer type part number 158000-162 for Stromberg-Carlson RP763C, Chassis ASR 120.

Glenn Tribbey
4421 10th Street
Menominee, Michigan 49858

Needed: Number of the type of transistors used in Metrex Genie multi-signal generator, Model MX-101. Manufacturer has gone out of business.

Murray Goldstein
8842 Grange Hill Road
Sauquoit, New York 13456

Needed: Schematic or service information for a Speco signal tracer; no model number is on the unit.

Patrick Waters
216 Lincoln Street
Westbrook, Maine 04092

Needed: Schematic and parts list for Clairtone S-200 AM/FM stereo. Will copy, or pay for use and return.

Ernest J. Kaufman
7402 Wyndam Road
Pennsauken, New Jersey 08109

Needed: Power Transformer Part Number 54-26 for Heathkit scope, Model 0-10.

Ferd Falland
164 Zane Street
Wheeling, West Virginia 26003

(Continued on page 16)



Fix it Quick...

with an

Ungar® Cordless Quick-Charge Soldering Iron

- Cordless portability
- Quick 4-hour charge
- Holder automatically charges high performance NI-CD battery
- Rigid coaxial tip rotates to desired working position
- Easy-touch switch, tunnel light
- Quick heat-up

SPECIAL OFFER

Free Micro-Spade Element Tip

Present this coupon to your local participating Ungar electronic distributor and receive a FREE #195 Micro-Spade Element Tip worth \$1.99 with your purchase of a #200 QUICK-CHARGE CORDLESS SOLDERING STATION.

HURRY! Offer EXPIRES December 1, 1976.



Division of Eldon Ind., Inc. • Compton, CA 90220



For More Details Circle (12) on Reply Card



Electronic Technicians are giving tuners a **BIG BATH**

(and taking advantage of a special premium offer)
BIG BATH is a superior quality tuner cleaner and degreaser, specially formulated to:

- penetrate dirt, dust and grime
- protect tuners from corrosion
- improve positive contacts
- high pressure chemical stream cleans thoroughly
- safe for plastics, will not detune

BIG BATH is for electronic technicians who count on dependable, quality products

- economical 24 oz. aerosol can
- easy to use pinpoint applicator
- available from electronic distributors everywhere

Cat. No. 10-903

SPECIAL PREMIUM INTRODUCTORY OFFER:

Receive Free Universal Color TV Alignment Kit

Includes:

- | | |
|-----------------------|-----------------|
| Zenith Alignment Tool | Hex Core Tool |
| Hex Wrench - 5" | Double End Tool |
| Hex Iron Core Tool | Shaft Extension |

Five of the most frequently used alignment tools for all standard adjustments in color TV. All tools are constructed of Delrin in various colors for easy identification and comes in a convenient pocket saver pouch.

Technician/dealers mail 5 Premium Labels from 24 oz. Big Bath directly to:

GC Electronics 400 S. Wyman
 Rockford, IL 61101 ATTN: Dept. RK

\$275
 VALUE



Cat. No. 8454



GC ELECTRONICS

DIVISION OF HYDROMETALS, INC.
 ROCKFORD, ILLINOIS 61101 U.S.A.



For More Details Circle (4) on Reply Card

YOU CAN BE SURE

MORE TIMES IN MORE CIRCUITS WITH SENCORE DIGITAL MULTIMETERS

SENCORE

A NEW BREED OF DVM's BACKED BY 25 YEARS OF ALL AMERICAN CRAFTSMANSHIP, WITH SIX EXCLUSIVE FEATURES, SO YOU CAN BE MORE SURE, MORE OFTEN AND ALL WITH HI & LO POWER OHMS FOR MEASURING ACCURATELY IN SOLID STATE CIRCUITS.



DVM35 \$124
3 digit LED display,
1% DCV accuracy,
battery or AC operated



■ **ONE THIRD LESS CIRCUIT LOADING** to make you sure that you are affecting the circuit being tested as little as possible for more accurate measurements. Sencore digitals are 15 megohm, others are 10 megohm.



■ **2000 DCV range** to make you sure that you can measure TV boost volts, scope voltages, medical equipment, etc. Other digitals stop at 1000 volts. High voltage probe extends measuring capabilities to 50 KV.



■ **PROTECTED INSIDE AND OUT** so you can be sure that your meter is working and not in the repair shop. Drop it from 10 feet, apply 1000 volts overload and even apply volts on ohms accidentally and Sencore digitals keep right on working.

[Continued from page 12]

Needed: Service manual with alignment data for Heathkit color TV, Model GR53. Will buy, or copy and return.

Rudolf J. Burtman
4762 N. Franklin St.
Philadelphia, Penn. 19120

Needed: Manual and schematics for National Radio NC-300 ham band receiver. Will buy, or copy and return.

Richard S. Meyer
Communications Electronics
134 Jims Run
McMechen, West Virginia 26040

Needed: Schematic and information on where parts can be purchased for a proximity switch to protect two large file cabinets.

Michael Daerda
4066 Flora Place
St. Louis, Missouri 63110

Needed: Schematic for old Philco Jr. Superhet Model 80 radio.

Wm. Daley
Rt. 1, Box 321
Arcata, Calif. 95521

For Sale or Trade: Eico 147A signal tracer, Heath 10-102 DC-to-5 MHz scope (recurrent sweep), and three power supplies: Eico 1020 30V/5a; 12V/3a fixed; and a 15V/1.5a variable. Also have Craig audio products service manuals and other service data. Will trade for good RF signal generator and/or good transistor curve tracer.

Michael J. Christian
7912 Woodglen Circle
Tampa, Florida 33615

For Sale: Issues of Shortwave Craft and Radio Craft magazines from 1935. Most years complete; make offer.

Orlette Watson
515 N. Highway 6
Clifton, Texas 76634

Needed: Schematic and/or manual for Mercury color generator, Model 1900. Will buy, or copy and return.

Jerry's Color TV
5510 Laverne Ave.
Parma, Ohio 44129

Needed: #1626 tube in good condition.

John J. Krajewski
P.O. Box 331
Sebring, Florida 33870



DVM36 \$148
3½ digit LED display,
.5% DCV accuracy,
battery or AC operated



DVM32 \$198
3½ digit LED display,
.5% DCV accuracy,
battery or AC operated
with automatic battery saver



DVM38 \$348
3½ digit LED display,
.1% DCV accuracy,
AC operated, auto-ranging,
auto-zero, king size pushbuttons



BATTERY SAVING FEATURES WHEN INSTRUMENT IS NOT IN USE so you can be sure that your meter will be ready the next time you need it. Push the button on the probe on the DVM35 and DVM36 and only then do you start drawing current from your battery. An automatic patented circuit does the same job for you automatically when you apply voltage to the DVM32. The DVM38 is AC operated.



10 DAY FREE TRIAL to be sure that Sencore digitals are all that we say they are. Simply march into your Sencore distributor and ask for a free trial or pay cash with a promise of a 10 day money back guarantee, if not 100% satisfied. Or, write Sencore, and we will see that our distributor contacts you.



100% MADE RIGHT LIFETIME GUARANTEE so you can be sure your meter was made right. If at any time you discover that a Sencore DVM was not made right, Sencore will make it right, parts and labor free of charge, for the lifetime of the product.

Plus other "make sure" features such as - direct reading with no parallax error - no effect from magnetic fields such as motors & RF fields - lab accuracy with high resolution - auto-polarity auto-zeroing and auto-ranging on the DVM38 . . . and you can see why you can be sure more times, in more circuits, than with any other multimeter on the market today - and for less money than old fashioned analog meters.

SENCORE 3200 SENCORE DRIVE
SIOUX FALLS, S.D. 57107

For More Details Circle (5) on Reply Card

Needed: Old RCA picture tubes: 15GP22, 12AP4, 7DP4. Also sales spec sheets for RCA TV, radio, etc., for any year up to present; RCA service data 1951-1964.

Carleton Sarver
256 West 88th Street
New York, New York 10024

Needed: Schematic/construction manual for Heathkit Depthsounder, Model DS-1. Will pay.

Larry Eystad
2300 Marinship Way
Sausalito, Calif. 94965

Needed: Schematic and component layout for a Gransonic Model GS-2 solid state stereo receiver. Will pay for copying.

Ye Olde TV Repair Shoppe
5659 W. Pico Blvd.
Los Angeles, Calif. 90019

Needed: Yoke for Ambassador AM7000WD-AM7118WD, #EP76X2.

Ed King
129 E. Marie St.
Hicksville, Long Island
New York 11801

Needed: Service data for the old McMurdo Silver "VOMAX" Model 900 VTVM.

Robert C. Pease
340 4th Ave.
Stanley, Wisconsin 54768

Needed: Schematic for Lake Model 20-5 portable radio. Will buy, or copy and return.

Paul B. Lee
8918 Sovereign Rd.
San Diego, Calif. 92123

Needed: Schematic/operating instructions for Accurate Instrument Co. "Genometer", Model 156. Also have for sale: Heathkit laboratory oscilloscope, Model 0-10, \$80; and Unicord Model UEQ-1 professional preamp-mixer, solid state, best offer over \$150 (original cost over \$300).

George O. Vincent
3 Summit Drive
Highland Mills, New York 10930

For Sale: RCA test equipment: WO-535A scope; transistor/FET tester WT-524A; and high sensitivity AC VTVM, WV-76A. Send self-addressed envelope.

Wm. D. Shevtchuk
One Lois Avenue
Clifton, New Jersey 07014

(Continued on page 18)

When you think of receiving tubes, think of RCA and the man who's got them all.



(Continued from page 17)

Needed: Back issues of electronics magazines, either hobbyist or servicing type, 1920-1975. Please state price and condition.

Donald Wall
8 Mill St.
North Reading, Mass. 01864

Needed: Schematic and service information for a Tokai TC 5008 23-channel CB radio.

Leonard A. Denney
LAD Electronics
P.O. Box 277
Neah Bay, Washington 98357

Needed: Schematic diagram for Arvin AM radio Model 444AM; chassis BE-200M. Will copy and return. Also need a flyback transformer for Sears color TV chassis #564.10200 or 564.10201; Model #7164, part #T-F86A.

John Brouzakis
R.D. 2, Box #602B
Charleroi, Penn. 15022

Wanted: A 15-watt 50,000 ohm power rheostat for an old Sprague Model T0-3 capacitor checker.

Raymond Parsons, Jr.
RFD 1 Portsmouth Ave.
Stratham, New Hampshire 03885

Needed: Schematic or tubes used in a Paco push-pull oscilloscope, Model S-50.

Edward E. Smith
5425 South 52nd Street
Omaha, Nebraska 68117

Needed: Schematic and manual for B&K in-circuit capacitor analyzer, Model 800. Will buy, or copy and return.

M&W TV
673 South Mollison Avenue
El Cajon, California 92020

Needed: Manual, schematic, and parts list for: Hallicrafter SX62 receiver; Simpson 415A generator; RCA WO78E scope; and Jackson capacitor analyzer. Will buy, or copy and return.

Russell Scarpelli
307 Main Street
Blakely, Pennsylvania 18447

Needed: Service data for United Scientific Labs Model CB7000 citizens-band transceiver; also, service data for an Army Signal Corps radio Model BC-342-N.

Captain Harry Liles
Route 2 Box 82
Brunswick, Georgia 31520



You name it and your RCA Distributor's got it. Glass tubes. Miniatures. Metal tubes. Novars. Compac-trons. Nuvistors. Nearly 1100 types — all of the highest quality standards — the same standards that have made RCA tubes the most widely used.

And he's got what you need when you need it. You can count on your RCA Distributor to be well stocked — ready to supply you with RCA receiving tubes at all times.

Plus you can get RCA service and business aids, too. Get all the help you need with our popular caddies, service tools, technical literature and a wide assortment of in-store signs and displays. Your RCA Distributor will tell you how to get them.

Get your share of gifts — Tear 'n' Share '76. This RCA dealer awards program runs through November 30, 1976. Don't miss your share of the rewards for using RCA receiving tubes and color picture tubes. Ask for a Tear 'n' Share '76 Prize Book.

See your local RCA Distributor for all your tube needs. RCA Distributor and Special Products Division, Building 206-2, Cherry Hill, N.J. 08101.

RCA Receiving Tubes

Needed: Operating manual for DuMont scope Model 401. Will buy, or copy and return.

Henry B. Craig
74 East 58 Street
Brooklyn, New York 11203

Needed: Operating manual for DuMont scope Model 304H. Will buy, or copy and return.

Troch's Television
290 Main Street
Spotswood, New Jersey 08884

Needed: Meter for Accurate Instrument tube checker Model 257, or details on type of meter.

Troch's Television
290 Main Street
Spotswood, New Jersey 08884

Needed: Zero-adjust control for a Precision VTVM Model EV-10.

T. L. Willis Radio & TV Service
P.O. Box 425
Salina, Kansas 67401

Needed: Operating information, schematic, and new tube chart for Model 805 tube/set tester by Radio City Products Company. Will buy, or copy and return.

Adrien Guay
375 Woodman Street
Fall River, Massachusetts 02724

Needed: Used electronic home-study course on TV servicing including color.

Nick DeBari
325-41 Street
Union City, New Jersey 07087

Wanted: Hickok Models 640 and 770 scopes in good condition.

Paul Capito
637 West 21st Street
Erie, Pennsylvania 16502

For Sale: Eico 460 scope, like-new condition. Also need basic kits for an electronic switch and trigger for the scope. Might consider trade.

A. Edward Ruppel
1207 Adams Street
Saginaw, Michigan 48602

Needed: Schematic and instruction book for Jackson FM/AM Universal signal generator, Model 641-A. Will send \$1.00 to help with postage.

Dale W. McMIndes
Trans World Radio
Bonaire, Netherlands Antilles

Needed: Power transformer for Hickok oscilloscope Model 670.

Walter Schiro
560 Eldridge Avenue
Novato, California 94947



John Simrell, service manager for Wilson Distributing in Kansas City, demonstrates service procedures for the Philco E21-4 chassis.

Philco E21 Chassis... Circuits and Servicing

Part 1

By John Simrell, Service Manager For Wilson Distributing

Since Philco facilities were purchased by GTE Sylvania, Philco models have been used as the standard line, while Sylvania models supply the deluxe features. That's why the E20 and E21 chassis described in this series are virtually the same in both brands. E20 chassis are used in 15" portables, while E21 versions operate 17" and 19" sizes. Part 1 covers the main power supply, including a tie-in with the pincushion-correction circuit, and the safety shut-down circuit that eliminates raster sound, and most of the voltage supplies when the voltage to the horizontal-output transistor rises too high.

Chassis E21 and E20 (sold under both Philco and Sylvania names, with only slight differences) are not modular types. They are 100% solid-state, and most small components are on one large circuit board. Other components are mounted on the CRT-socket board, the convergence board, and on a narrow board (with the secondary controls) along the top at the rear.

The low-voltage B+ regulator of the E20 is adjusted for +107 volts, giving about 22 kilovolts of high voltage, and the E21 should be set for +112 volts to produce about 27 KV. Also, maximum audio power is a bit higher with E21. Sylvania versions of E21 have a count-down circuit instead of a vertical oscillator.

Both chassis have transformerless (hot-chassis) types of power supply; therefore, normal safety precautions should be taken when you operate one of these receivers without the back cover.

No horizontal-hold control is provided. The sine-wave oscillator is so stable that only the core of the oscillator coil is adjustable; and this coil is located near the front edge of the chassis.

Correction of pincushion distortion at the sides is accomplished by modulating the 107/112 regulated supply voltage. We will explain this later. If you don't understand the

purpose of the extra waveform, you might wrongly believe the supply had too much hum.

Only the horizontal oscillator, driver, and output stages are powered from the regulated supply which comes from the line voltage. All other voltage supplies are obtained by rectifying horizontal-sweep signals.

A shorted B+ regulator transistor (or other regulator defects) could allow the high voltage to rise to dangerous levels. Therefore, a "shut-down" circuit monitors the regulated voltage. If the voltage rises above +125 volts, the circuit removes the horizontal drive, shutting down the high voltage and the voltage sources that rectify horizontal sweep signals.

The Main Power Supply

In Figure 1, L502 and C502 are used to minimize "silicon-radiation hum bars", SW500 and CB500 are the on/off switch and circuit breaker, and diode SC504 is the only rectifier operating from the power line. From the anode of SC504, AC power goes to the degaussing circuit (which uses a positive-temperature-coefficient (PTC) resistor to stop the current), and to the heater transformer for the picture tube.

R504-1 is the surge resistor that limits the maximum current when the receiver first is turned on, and

C520 is the peak-reading filter capacitor. Output from this conventional rectifier circuit is about +150 volts.

Regulation

The maximum high voltage is affected by only two adjustable factors: third-harmonic tuning of the flyback; and the amount of DC voltage applied to the horizontal-output transistor. A series-transistor circuit determines this voltage and regulates it. Then, because the regulator could go bad and produce excessive HV, a safety "shut-down" circuit is added.

Transistors Q500 and Q502 are connected in a Darlington circuit, which gives better gain. Power transistor Q502 is mounted on the left side shield, as shown in Figure 2.

With regulators of this kind, the first step is to supply a stabilized voltage that's just about 1 volt higher than the final regulated voltage. The stabilized voltage is used to clamp the base of the regulator. In this case, a horizontal-sweep signal is rectified to supply +170 volts. A sample is regulated by R512 and zener SC514, giving +120 volts which feeds R514, the 112-volt adjustment pot. Voltage from R514 goes through R516 and R519 to the base of Q500 (effectively the base of the regulator,

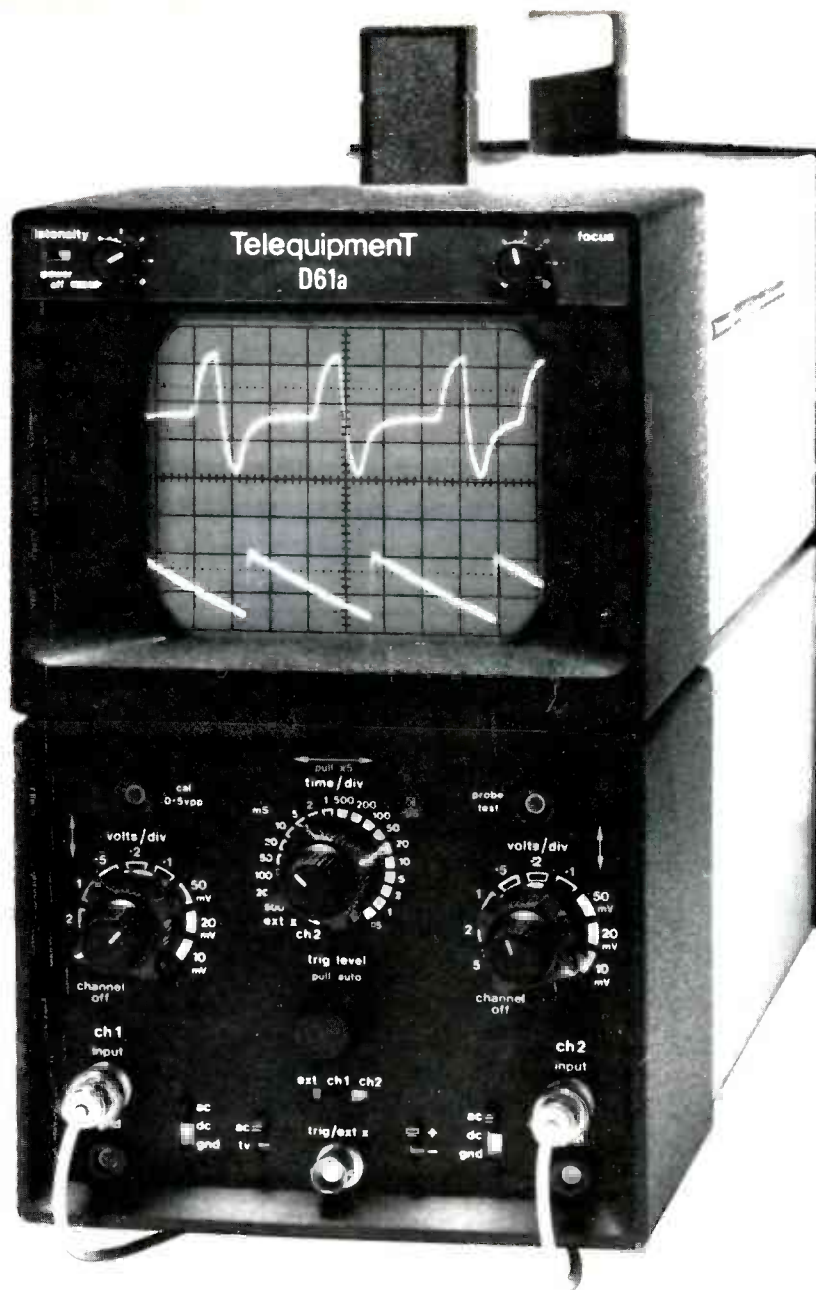

A NEW LOW-COST, DUAL-TRACE SERVICE OSCILLOSCOPE FULLY BACKED BY TEKTRONIX

Now for only \$595 you can get a portable, 10 MHz dual-trace service oscilloscope. The 18 lb TELE-EQUIPMENT D61a has front-panel controls that are easy to understand, easy to use. Full-sensitivity X-Y gives you vector displays that are in true phase relationship—displays that you can rely on. And automatic selection of alternate or chopped mode and automatic selection of tv line or frame triggering

make this oscilloscope ideal for classroom use as well as the service shop.

D61a features a bright 8 x 10 cm display, and 10 mV sensitivity in dual-trace and X-Y operation. It is fully backed by a standard Tektronix one-year warranty and may be serviced at any of 50 Tektronix Service Centers nationwide. Call your nearest Tektronix Field Engineer or circle the reader interest

number below for specifications and ordering information on the new D61a and other low cost TELE-EQUIPMENT Oscilloscopes.



P.O. Box 500
Beaverton, OR 97077

since Q500 is wired as an emitter follower). These two resistors are required to isolate the safety circuit (SC512) and the pincushion waveform from the stabilized voltage.

Redundant safety circuit

Now that we have mentioned the safety circuit, perhaps it should be explained. If zener SC514 should open, the base of Q500 (and ultimately the output of the +112-volt supply) would rise nearly to the +150-volt source voltage. However,

R507-1 and R505-1 form a voltage divider to give about +130 volts. When the voltage at the junction of R516 and R519 tries to rise above that voltage, diode SC512 conducts (it normally is reverse biased) and clamps the anode voltage to the +130 volts from the voltage divider. The regulated +112 supply rises somewhat, but not so much as if the extra redundant safety circuit were not there. You could call this a backup safety feature, operating in addition to the shut-down circuit.

Emitter-follower regulation

When Q500 is used as an emitter follower to drive Q502, the effect of a voltage or signal applied to the base of Q500 is exactly the same as though it were applied direct to the base of Q502, except the base impedance is higher, making the operation more effective.

To that information, add the fact that the regulation action of Q502 is an emitter-follower operation. When the base of Q502 is clamped to a fixed voltage (as it is through Q500), any change of Q502 emitter voltage is an actual change of Q502 bias.

Suppose the emitter voltage of Q502 goes down for any reason. That is an increase of forward bias, and Q502 draws more current (reduces C/E resistance) which increases the emitter voltage to almost the original value. Of course, an increase of regulated voltage is partially corrected by a decrease of C/E current because of the decreased forward bias.

R526 and R528 (see Figure 3) parallel the C/E elements of Q502, so not all the load current passes through the transistor.

Pincushion correction

Wide-angle deflection expands the corners of the picture, and most receivers correct the distortion at the sides by loading-down the horizontal sweep circuit at the top and bottom of the raster to narrow the width there. These Philcos narrow the width at top and bottom by applying a parabolic waveform of about 10 volts PP to the 112-volt regulated voltage for the horizontal-output transistor. The waveform is shown on the schematic of Figure 1, and it comes from the pincushion circuit through C820 to the base of Q500 regulator driver. Q500 and Q502 are emitter followers, so the waveform is passed along to the output.

Shut-Down Protection

No adjustment is provided for the amount of high voltage, except for the voltage from the regulated supply. If Q502 should develop a collector-to-emitter short, the high voltage of Chassis 21, for example, might soar to about 36 KV. This excessive voltage could cause arcing in the CRT or the HV circuit, or

LECTROTECH 50 MHz FREQUENCY COUNTER

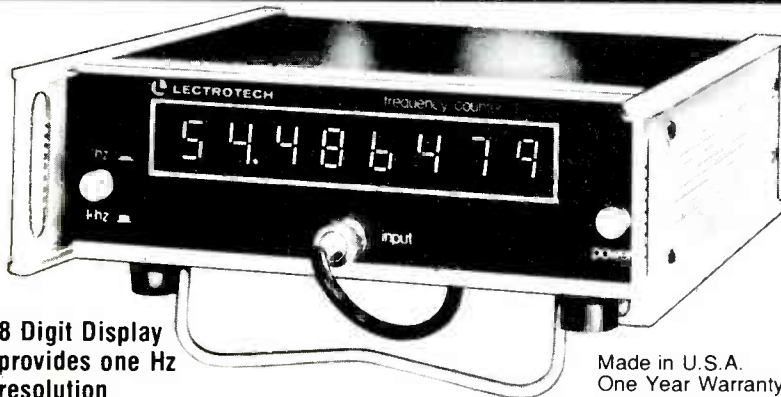

- 8 Digit Display provides one Hz resolution
- 50 MHz Guaranteed

FC-50 Frequency Counter is the ideal instrument for measuring frequency and adjusting CB, Business Band, Marine and other radio receivers and transmitters up to 50 MHz including scanner crystal frequencies.

- 8 Digit Display eliminates the need for overflow, no memorizing of first 2 most significant digits.
- Operates from both AC and DC power sources. FC-50 is capable of operation from 12 volt DC source such as auto battery with optional cigar lighter attachment. Permits CB frequency checks directly in vehicle. (Other accessories available for complete CB servicing)
- New LSI (Large Scale Integration) frequency counter circuitry provides precise accuracy in servicing and greater reliability at lower cost to you

... net only **\$19950**

SPECIFICATIONS:

Frequency Range: 10 Hz to 50 MHz. **Number of Digits:** 8 full digit display. **Digit Size:** 0.5 inch. **Resolution:** 1 second gate—1 Hz. 1 m-sec gate—1 KHz. **Gate Times:** 1 second and 1 milli second. **Sensitivity:** 30 mv RMS to 40 MHz. 50 mv RMS 40 to 50 MHz. **Input Impedance:** 1 megohm and 30 pf. **Connector:** Front panel BNC. **Input Protection:** Max Input, DC and AC Peak. Frequency Range—10 Hz to 100 KHz./250 Volts, 100 KHz to 5 MHz./100 Volts, 5 MHz to 50 MHz./50 Volts. **Line Voltage Stability:** Better than ± 1 PPM after 30 min warmup. **Time Base Stability:** ± 1 Hz. **Temperature Stability:** Better than ± 10 PPM from 0-50 Deg. C. **Power Requirements:** 105-130 V. 60 Hz. 15 Watts max., or operation from 12 volt car battery with optional cigar lighter attachment cord. **Size:** 2.5 x 8.25 x 8.25". **Weight:** 4 lbs. **Handle:** Combination carrying handle and tilt stand.



See your distributor or write:

LECTROTECH, INC.

5810 N. Western Ave., Chicago, Illinois 60659 (312) 769-6262

For More Details Circle (7) on Reply Card

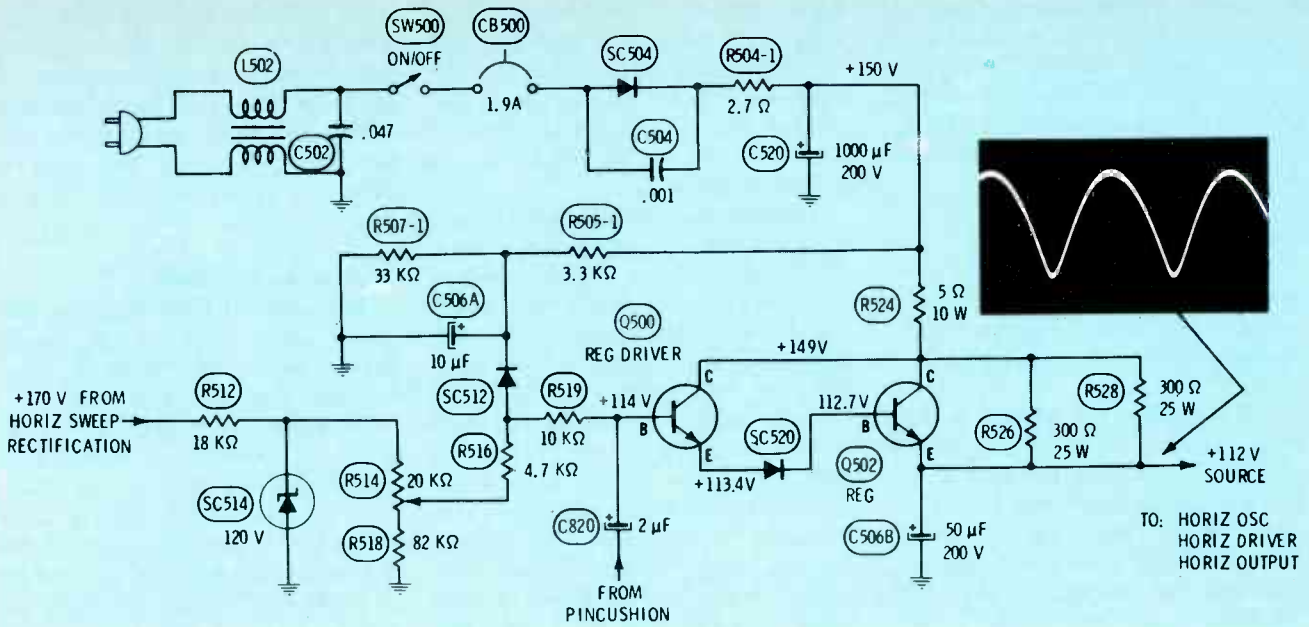

Fig. 1 This is the schematic of the main power supply and regulated source for Philco E21 chassis (Chassis E20 is the same, but the supply is set for +107 volts). The parabolic waveform should be found at the base and emitter of Q500, also the base and emitter of Q502. Operation of the regulator can be understood more easily if you eliminate Q500 and connect the base components to the base of Q502.



Fig. 2 Q502 regulator power transistor is mounted on the left side panel (your left as you face the set from the rear). The filter capacitor can and several high-wattage resistors are on the other side of the panel.

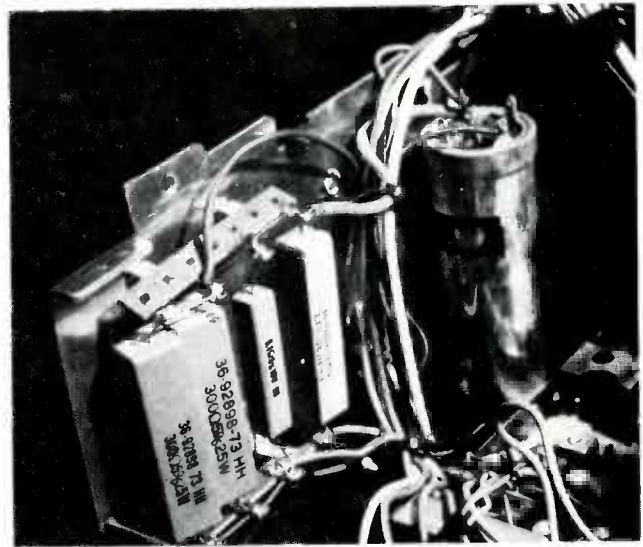

Fig. 3 Here are C520 filter can, R526, R528, R524, and R504 mounted around the socket for Q502.

X-rays might be generated in the picture tube.

Therefore, a "shut-down" circuit, which does NOT have an adjustment, is included. Any regulated voltage above +120 volts should trigger the shut-down SCR. After this circuit has been activated, the symptoms are: heater of the CRT is lit normally; regulated voltage is about +160 volts, and the other voltage supplies measure nearly zero. Regulation has been lost along with the horizontal sweep,

and the voltage rises because the horizontal-output transistor is not drawing current. Let's analyze the circuit.

SCR switch

SCR's are special diodes with a control element called a "gate". Even when the anode is positive, relative to the cathode, no conduction takes place until the gate becomes +0.7 volt (or more) from the cathode. Also, after anode conduction has started, it continues

until the current drops below the latching point, even though the gate no longer is positive.

This latching ability is an important factor in the shut-down circuit. Figure 4 shows the entire circuit, which is activated either by excessive 112-volt regulated voltage, or from excessive current in the +29-volt source.

The anode of SCR430 is connected between R430 and R438, the horizontal-oscillator load resistors. Signal for the base of Q400



What d'ya mean, you can't fix CBs?

Introducing the Sylvania ECG™ CB10-4 service kit.
26 semiconductors that can turn CB problems into profits.

Until now, the toughest problem in handling CB repair jobs was getting the right replacement part.

Now, we've put the solution to 1,047 of these parts problems in one kit that will fit right on your bench.

The CB10-4 kit has 23 transistors and 3 integrated circuits that are the most frequently needed replacements in transceivers and other CB equipment. And the interchangeability

guide that comes with the kit tells you the right ones to use as replacements.

With the CB10-4 most of your parts needs are right at your fingertips. And you can get the others in the same place you bought the kit—at your Sylvania distributor.



We're helping you make it.

GTE SYLVANIA

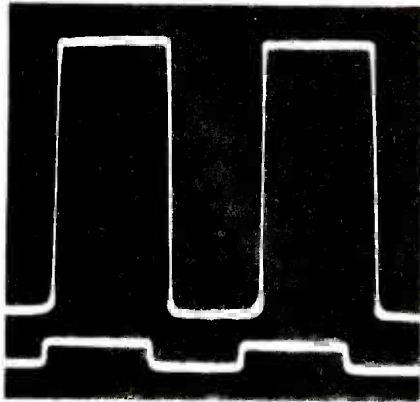

Fig. 5 The top waveform shows the normal 3-VPP drive signal at the base of Q400, horizontal driver transistor; and the lower trace is the small signal there after the SCR has conducted.

SCR430, which conducts and kills the horizontal drive. In turn, this eliminates all power except the main supply. The symptoms now are the same as those produced by excessive regulated voltage.

When the current overload is only temporary (perhaps your test probe slipped), normal operation can be restored by waiting with the power off for 45 seconds or so (until C432 discharges completely), and then turning on the power again.

Troubleshooting Tips

Here is the system I use when the

symptoms indicate that the shutdown circuit is operating and has disabled the receiver:

- Measure the +112-volt supply at the emitter of Q502; if it is very low, the supply might have a serious short, such as a shorted horizontal-output transistor. An abnormally high reading could mean a shorted Q502, an open output transistor, or any defect that has fired the SCR;

- Scope pin 15 of the horizontal oscillator (IC400). About 3 VPP is normal when the SCR is not fired, around 0.5 VPP indicates the SCR is conducting, and zero might suggest the IC is bad;

- Check for +20 volts at pin 16 of IC400. If it is zero, test to find out why. If it is +20 and there is no drive, the IC400 probably is bad, so replace it;

- If there is no horizontal output with a new IC400, check other components associated with it, such as C416 and C418;

- If the output of IC400 pin 16 is weak and the gate of SCR430 measures +0.6 volt or higher, the SCR is conducting, perhaps because of excessive current in the +29-volt supply;

- Remove Q504, the current-limiter transistor, connect a meter to the +29-volt source and turn on the power. Excessive current will give a low voltage, make some resistors run hot, or manufacture a small spiral of smoke. Prime suspects are

the vertical and sound output stages, if so;

- If there is no overload on the +29-volt supply, the basic defects narrow to only two: excessive 112-volt supply voltage with normal current; or no current in the horizontal-output transistor;

- Remove SCR430, and insert the power plug (but keep your hand on it). If you hear the rustling sound of high voltage at the picture tube, the horizontal is okay, and the regulator has too much voltage. **Unplug the cable immediately**, before the excessive HV arcs and causes damage;

- Check for a shorted regulator transistor, Q502 (or driver Q500).

These tests cover most component failures. As you can see, many different defects trigger-on the SCR and raise the regulated voltage up to about +160 volts.

Incidentally, an open Q502 (or Q500) forces R526 and R528 to supply all current of the horizontal-output stage. When that happens, the regulated voltage drops to around +90, and the picture is small and dim. Measure the forward bias from base-to-emitter. If it is higher than +0.7 volt, but there is no collector current, the transistor is open.

Next Month

Horizontal sweep and high voltage circuits of the Philco Chassis E21 are the subjects next month. □

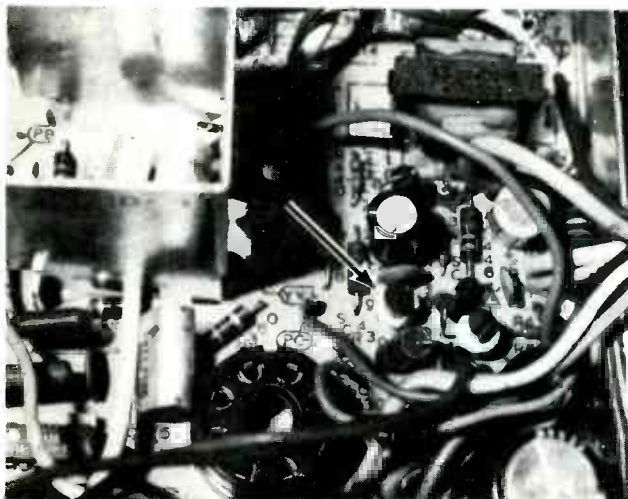

The center arrow points to SCR430, which is located near the yoke socket. Q504, the current-limiter transistor, is just to the right of SCR430.

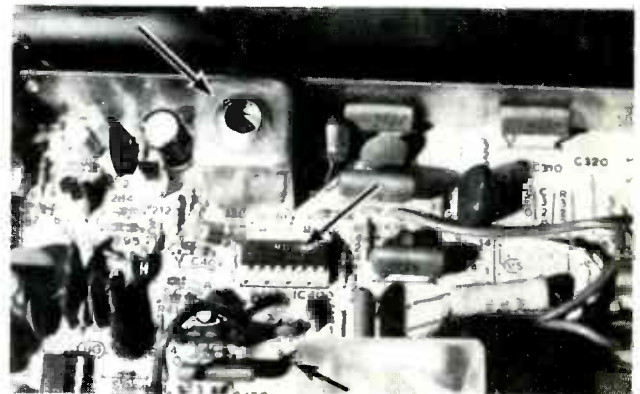

L418, the horizontal-oscillator transformer, is pointed out by the arrow at the top; the oscillator integrated circuit (IC400) is identified by the center arrow; and test point "SS" is shown by the arrow at the bottom. To set the horizontal oscillator, ground TP-SS, adjust L418 so the picture drifts slowly sideways, and remove the ground from the testpoint.

PHENOMENAL BREAKTHROUGH IN UHF RECEPTION!

Don't say you can't get good UHF reception until you've tried this new combination by Winegard

New Super Lo-Noise Preamp With New Antenna Makes Poor Pictures Good and Fair Pictures Excellent

Good reception of UHF stations is more important than ever. Programming has greatly improved in recent years on the U's and many offer exclusive sports coverage viewers so eagerly want. If you sell sets or install antennas in UHF areas, you know what we're talking about.

The Problem

You also know what we're talking about when we say that reception of UHF stations in most areas is rarely as good as you get on the VHF stations. This is a major, universal problem.

Why the problem? For one thing, many UHF stations are not on full authorized power. And, transmission line losses at UHF frequencies present difficulties. But the biggest culprit of all is the high noise figure of the TV set tuners at UHF frequencies.

Generally speaking, you have to deliver 3 times as much clean UHF signal to the set as you do VHF signal—in order to get comparable reception.

The quantity and quality of UHF signal you feed the set is greatly determined by the antenna and preamplifier you use.

| SPECIFICATIONS | AC-4990 |
|---------------------------|------------|
| GAIN | |
| UHF | 17.5db |
| BANDPASS (MHZ) | |
| VHF-FM | 54 to 216 |
| UHF | 470 to 890 |
| MAX. TOTAL OUTPUT (Volts) | |
| UHF | .882 |
| MAX. TOTAL INPUT (Volts) | |
| UHF | .126 |
| NOISE FIGURE | |
| UHF | 2.2db |

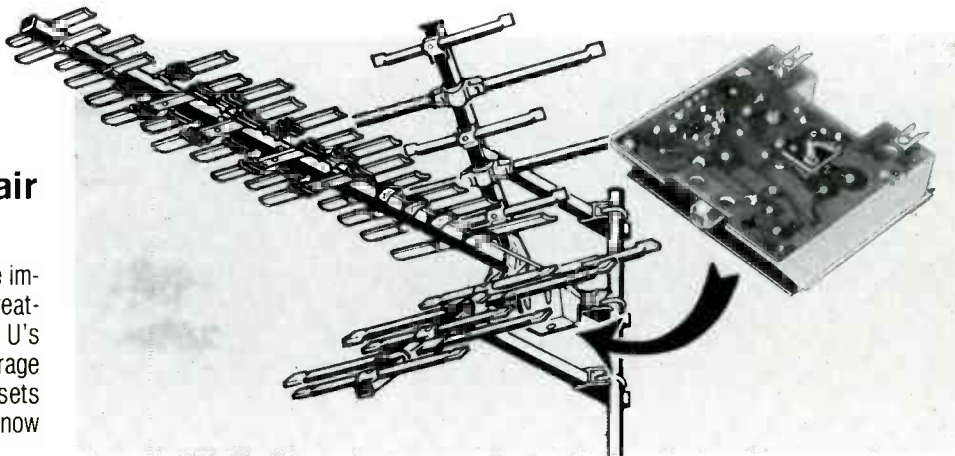

Winegard AC-4990 Preamplifier Combined With CH-9095 Antenna Delivers Amazing UHF Reception.

The Solution

A few months ago Winegard Company introduced a new line of Chromstar UHF antennas featuring a new Tri-linear director system. This configuration offers the highest gain we've ever seen on a UHF antenna and the field reports we've been getting from professional installers have been most enthusiastic.

Now Winegard Company is introducing another...and even bigger breakthrough. This is a super lo-noise UHF preamplifier, Model AC-4990.* It has a 6db signal-to-noise improvement over the best UHF preamps previously available.

Combine the AC-4990 with a Winegard CH-9095 Chromstar UHF antenna and you get a 9db improvement or 3 times cleaner signal.

This means you can give good UHF pictures to customers who can barely get UHF now. It means you can deliver "excellent" reception to those who now receive just "fair" pictures.

*Pat. Pending.

In actual practice, good reception of all UHF stations is now extended up to 30 additional miles...in many cases nearly doubling the effective reception range.

New Sales Potential

Potential sales of CH-9095's and AC-4990's are greatly increased. This combo can be sold in areas where UHF reception hasn't been good enough to bother with *and*, as a replacement for customers who are only getting "fair" reception now.

Incidentally, the AC-4990 preamp has a VHF bypass so it can also be used with any Winegard V-U Chromstar antenna with excellent results.

Antenna dealers in UHF areas are advised to try this new Winegard antenna-preamp combination as soon as possible. Seeing is believing...and the new profit opportunities are tremendous.

NOTE: Due to demand, the AC-4990 preamp will be in short supply for a few months. An order should be placed now with your Winegard distributor.



WINEGARD
C O M P A N Y

3000 Kirkwood • Burlington, Iowa 52601

CB Test Readings... Right Or Wrong?

Part 2/By Marvin J. Beasley, CET
Land Mobile Regional Manager, E. F. Johnson Company

A section of coax cable acts as a short circuit at a certain frequency determined by the length. You can imagine the wrong transmitter readings that result. This is just one of the conditions to avoid, when you check CB radios. Also, a complete list of receiver measurements is given for your guidance.

COAX OPEN-END IMPEDANCE

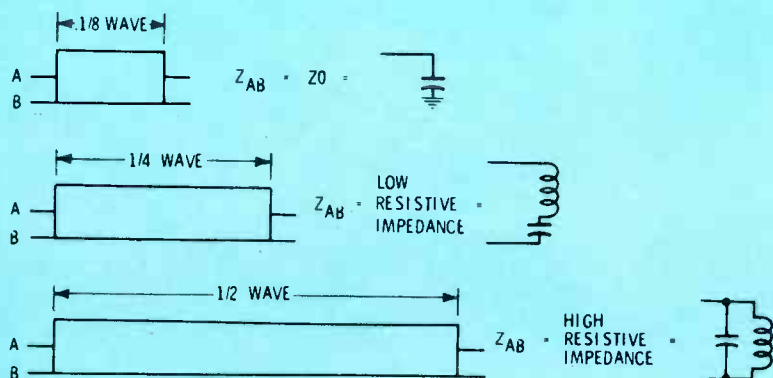
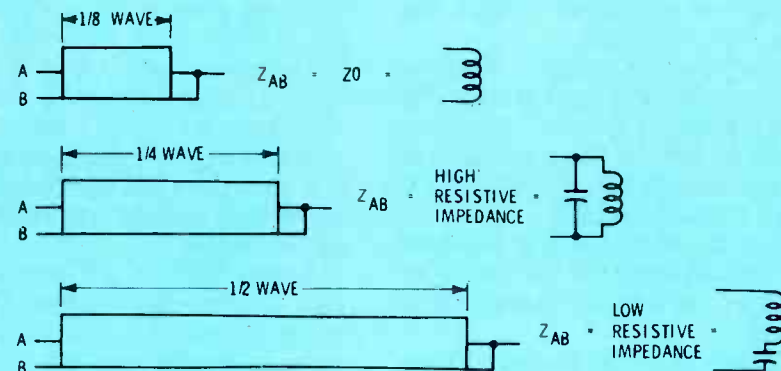

Fig. 1 When it isn't loaded properly, coax cable acts as a short or an open circuit, depending on the length of cable and the frequency. An open-ended piece of coax acts as a capacitance when the length is $1/8$ wavelength. At $1/4$ wavelength, the input of the cable has a low resistance. When it is $1/2$ wavelength, the cable appears to be a high resistance.

COAX CLOSED-END IMPEDANCE



Z_0 = CHARACTERISTIC IMPEDANCE OF CABLE

VELOCITY FACTOR OF RG58 AND RG8 IS .66 FOR SOLID DIELECTRIC AND .79 FOR FOAM

| CABLE LENGTH | FOAM | SOLID |
|--------------|-------|-------|
| 1/4 WAVE | 7.2' | 6' |
| 1/2 WAVE | 14.4' | 12' |

Fig. 2 A short at the far end of a coax cable reverses the characteristics obtained from an open cable. At $1/8$ wavelength, the coax input seems to be a small inductance; at $1/4$ wavelength the impedance is high; however, the impedance is low at $1/2$ wavelength. The physical length is determined by the kind of cable and the frequency.

Hidden Traps

An effective and inexpensive RF trap for minimizing interference to a TV receiver can be made by connecting a length of 300-ohm twin-lead in parallel with the antenna wires at the back. The wire should be slightly longer than $1/4$ -wavelength of the interfering signal. As the technician watches the interference on the screen of the TV, he snips small pieces from the open end of the twin-lead. The intention is to stop with the length that minimizes the interference. Of course, if you overshoot the mark, just start over again with a new piece of twin-lead.

Coaxial cable also exhibits the same kind of resonant shorts and opens to RF signals. Figure 1 shows how the input impedance of an open-ended cable changes according to the wavelength. Less than $1/8$ -wavelength produces only a capacitive effect; $1/4$ -wavelength acts as though a series-tuned circuit (low impedance) is connected across the input; and a $1/2$ -wavelength of cable produces a high impedance, as though a parallel-tuned resonant circuit is across the input.

Of course, these effects change gradually with length, so a cable between those wavelengths gives a blend of the two characteristics.

The input impedances of different lengths of shorted-output coax cables are shown in Figure 2. Notice that the **actual** length depends on the velocity factor of the cable (the dielectric in this case makes a difference).

When using coax to wire the test equipment and dummy loads, **you should select lengths of coax which will not give wrong test readings.**

For example, an open 3-inch stub and connector (Figure 3) reduced the transmitter output power by $1/2$ watt. And an open-ended 6-foot piece of coax reduced the output to only 0.6 watt (Figure 4). **Especially watch out for any 6-foot coax cables!**

Never leave an open-ended cable connected in parallel with the output of the radio. That's why we suggested last month that the coupling capacitor to the frequency counter should be located at the

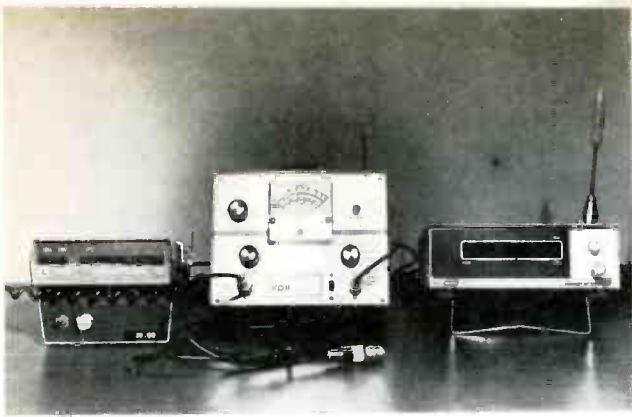

Fig. 3 The 3-inch stub of cable with connector was disconnected from the counter, causing a 1/2 watt loss of power when it was left open.



Fig. 4 The worst possible condition is to have a 6-foot coax with nothing connected to the far end. In one case, the output power was reduced to only 0.6 watt.

dummy-load end of the cable, and not at the counter (see Figure 5).

Even assuming a perfect counter having a high input impedance (no loading effect) and the ability to handle the full output of the transmitter without any overload inaccuracies, serious errors can occur during power-output measurements because of the length of coax cable that connects it to the transmitter.

Therefore, **some effective kind of decoupling always should be used between the transmitter output and the coax that feeds a scope or a frequency counter.**

To avoid a mismatch caused by adding a decoupling network across the dummy load, the total impedance of test equipment and decoupling system should be 10 times (or higher) than the resistance of the load. Such operation is called "bridging". It prevents excessive loading at the expense of a loss of voltage reaching the test equipment. And of course, both conditions are desirable in this case.

A simple resistive voltage divider would fulfill the specifications for a bridging decoupler, but experience has shown that a small coupling capacitor feeding a 50-ohm load works better.

The computation giving the value of the coupling capacitor is simple, and we'll give an example, in case you need a different voltage for your test equipment. First, we need to know the voltage coming from the transmitter, then we solve the voltage-divider values to reduce the signal to 1 volt. Finally, we determine the capacitance equalling the loss resistance.

Wattage equals voltage-squared divided by the resistance. Solving for voltage yields: voltage-squared equals wattage times resistance.

Assuming 4 watts across 50 ohm dummy load, that becomes: voltage-squared equals 200 (4 times 50). Taking the square root gives 14.14 volts of transmitter output signal.

A voltage divider to give 1 volt from 14 requires that the top resistance be 13 times the lower one. Since the bottom one is 50 ohms (the input of some counters), the top one is 650 ohms. Next, we need to know the capacitance value having a capacitive reactance of 650 ohms at 27 MHz.

The value of a capacitor equals the reciprocal of 2 Pi times the frequency (27 MHz) times the capacitive reactance. In this case, the required value is slightly over 9 picofarads.

Notice that the voltages across

the dummy load are high enough to be measured easily. However, you should use an RF voltmeter, or at least an RF probe matched to a voltmeter or digital meter. The AC ranges of most meters cannot measure frequencies that high. Some VTVM's might cover the frequency, but the capacitance of the shielded probe and cable would act as an excessive load, leading to errors.

Receiver Measurements

Service manuals for CB radios specify the signal level of the modulated carrier from a generator that is applied to the receiver input, and what audio-output wattage it should produce. When you have the proper equipment, it's easy to determine whether or not the receiver meets the specs.

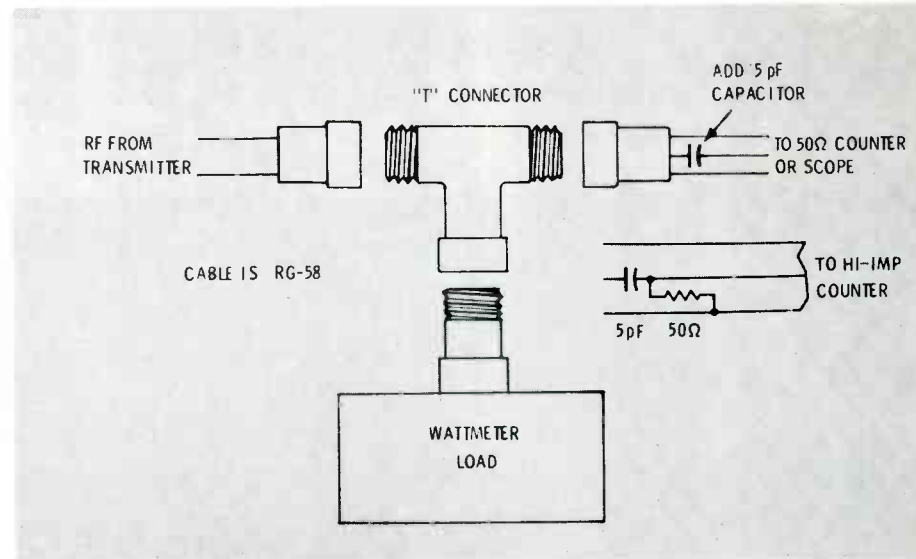

Fig. 5 Any cables that are not matched correctly should be decoupled at the input end (not at the output) to prevent loss of power from the trap effect. A scope or frequency counter with a 50-ohm input should be decoupled at the input of the coax by a 5 picofarad capacitor. If the scope or counter has a high-impedance input, then add both a 5 picofarad capacitor and a 50-ohm carbon or composition resistor (make sure the resistor is on the counter side of the capacitor).

But it's not easy on the ears of anyone around you when you're listening to a loud 1000-Hz audio tone. So, I recommend that you build a speaker/load test box, such as the schematic in Figure 6. Terminals are provided for an external meter, scope, or audio analyzer, and a flip of the switch gives either a 8-ohm dummy load or the internal test speaker. A pure-resistance dummy load is recommended because the impedance does not change with frequency, as a speaker does.

The following items of test equipment are recommended for speed and accuracy during receiver measurements:

- a signal generator covering both the 27-MHz band and the IF frequencies. The RF output should be calibrated down to 1 microvolt, or less, and the modulation should be adjustable;
- a VTVM, FET meter, or digital multimeter for DC voltage tests, audio AC measurements, and resistance readings; and
- a scope having bandwidth at least up to 100 KHz (5 MHz is better, and 30 MHz would be ideal for the transmitter also).

In addition, a high sensitivity AC meter (that reads down to 1 millivolt) and an audio generator can be very helpful.

Typical tests

If you have a service manual for the CB receiver, then follow the gain and power tests as listed. However, many receivers give simi-

lar readings, so after some experience you should be able to estimate whether or not the sensitivity is normal.

For example, an E. F. Johnson Model 124 should have not less than 0.775 volts RMS (zero dB) across the speaker on channels 1, 11, and 21 when a 1-microvolt 30%-modulated generator signal is applied to the receiver input. The reading is taken with the volume control full on, and a typical reading is 1.5 volts.

One more thing: Johnson always specifies the signal level into a 6-dB pad between the generator and the receiver. In other words, a 1-microvolt generator signal is 0.5 microvolt at the receiver. Some generators have the dial calibrated for use both with and without the pad. Also, some manufacturers specify the actual signal level at the receiver. Just be sure which standards are used.

Sensitivity measurement

Use this sequence of tests to determine both the minimum sensitivity and the signal-to-noise ratio:

- Turn the receiver "squelch" control to maximum (where it does not kill the sound even at weak signals);
- Tune the radio to Channel 11;
- Set the signal generator for 1 microvolt modulated 30% at 1000 Hz on Channel 11 and connect it to the receiver input through a 6 dB pad;
- Adjust the receiver volume control for a -10 dB indication on the

audio voltmeter (Simpson 260 or equivalent) which is paralleled across the speaker dummy load; and

- Switch off the modulation of the signal generator.

The reading of the audio voltmeter should drop 8 dB, or more. However many dB's it drops is the signal-to-noise ratio at 0.5 microvolts.

If the receiver does not reach the -10 dB reading with the volume control at maximum, the receiver gain is weak.

If the dB reading drops less than 8 dB when the modulation is turned to zero, the receiver is noisy.

Overall gain test

Use similar test conditions to measure the overall receiver gain, except turn the volume to maximum and check Channels 1, 11, and 21. Audio voltage across the dummy load (8 ohms) should be 0.775 volts RMS (zero dB) or more; most receivers will show about 1.5 volts during this test.

Measuring audio gain

It's best to troubleshoot for distortion or weak audio gain by injecting a signal from an audio generator to the radio volume control, and then checking the signal level and waveform at each audio stage.

Again using the Johnson Messenger Model 124 as an example, a 1000-Hz sine-wave of only 0.00235 volts (2.35 millivolts) at the volume control should produce 2.5 volts

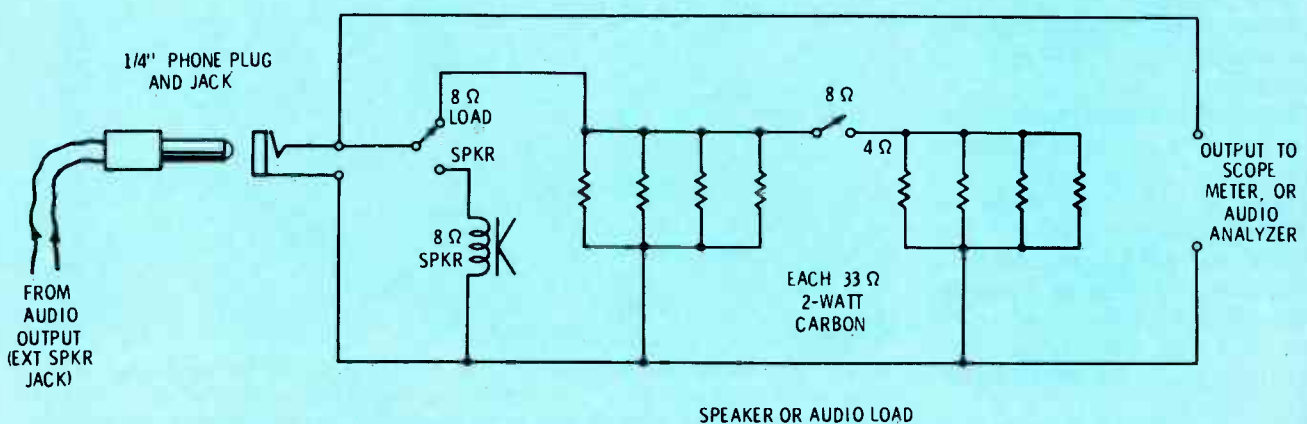

Fig. 6 Build this audio load circuit in a box with the test speaker. Measurements made with the 8-ohm dummy load are more accurate and easier on the ears. The output terminals are convenient points to connect test equipment.

Chart 1.
Typical AGC Voltages

| Input signal in microvolts to 6-dB pad | Relative output level in dB | AGC voltage at T5 #2 |
|--|-----------------------------|----------------------|
| 1 | -2 | .98 |
| 3 | +6 | .85 |
| 10 | +7.8 | .56 |
| 30 | +8.4 | .40 |
| 100 | +8.8 | .31 |
| 300 | +9.3 | .25 |
| 1,000 | +10 | .20 |
| 3,000 | +10 | .17 |
| 10,000 | +9.8 | .13 |
| 30,000 | +9.6 | .08 |
| 100,000 | +9.5 | -.02 |
| 300,000 | +10 | -.20 |
| 1,000,000 | +13 | -.25 |
| 3,000,000 | +14 | -.04 |

Conditions: 1,000 microvolts to 6-dB input pad, 30% at 1,000 Hz on Channel 11, volume control set for 2.5 volts across the speaker voice coil.

Chart 2. Signal Injection Tests

The following signals should produce 2.5 volts across the speaker of a Johnson Model 124 CB radio during signal-injection tests.

| Test point | Frequency | Input level |
|---------------------|------------|-----------------|
| Antenna input | 27.085 MHz | 1 microvolt |
| Base of 1st mixer | 27.085 MHz | 17.5 microvolts |
| Base of 2nd mixer | 4.3 MHz | 60 microvolts |
| Base of 1st IF | 455 KHz | 405 microvolts |
| Base of 2nd IF | 455 KHz | 12 millivolts |
| Collector of 2nd IF | 455 KHz | 1.1 volts |

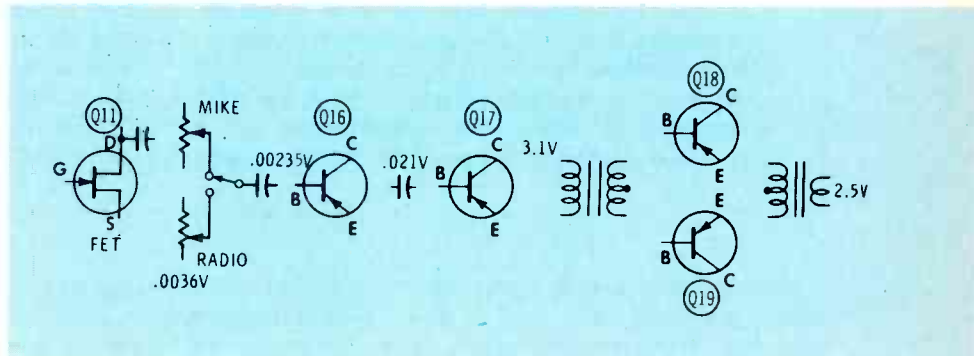

Fig. 7 These 1,000-Hz signals of the amplitude shown should produce an output of 2.5 volts RMS from a Johnson Model 124, during signal-injection tests.

across the 8-ohm speaker dummy load.

Now, you should understand why I recommended a **sensitive** (amplified) audio AC voltmeter; such low levels will appear to be zero if measured on the AC range of a VTVM.

Of course, if the audio is dead, or very weak, it might be impossible to obtain the 2.5 volts at the output. In that case, apply 0.0036 volts to the top end of the radio volume control and adjust the control for 0.00235 volts at the base of Q16. Then check the other stages, as shown in Figure 7. The point at which a weak or distorted signal appears indicates the location of the defect.

AGC test

Here are the steps for checking AGC action:

- Tune the radio to Channel 11, and turn the squelch so weak signals can be heard;
- Adjust the signal generator to Channel 11, using a strong output of 0.1 volt modulated 30% by 1,000 Hz audio;
- Rotate the volume control for a -10 dB indication on the audio meter;

- Reduce the RF input level to 10 microvolts—the audio should drop by 5 dB;

- With the signal remaining at 10 microvolts, reset the volume control to produce -10 dB;

- Reduce the signal to 1 microvolt. Audio output should drop by 12 dB.

There is little AGC action with weak signals, so the audio sound increases in step as you raise the signal level. But the AGC is more effective when the signal is stronger. Above a certain minimum level, the stations should appear to have the same strength.

This is illustrated by the signal versus voltage readings of Chart 1.

A list of the signal amplitudes and frequencies used for signal injection is shown in Chart 2.

Squelch test

Rather than merely rotating the squelch knob to see if the background noise and weak signals can be brought in and out, you should use a more scientific procedure, such as the following:

- Tune the receiver to Channel 11, and remove all connections from the antenna input;

- Adjust the squelch control so the background noise just barely disappears;

- Prepare a signal generator for 1-microvolt output on Channel 11, with 30% 1,000-Hz modulation;

- Connect the signal generator to the antenna input. The squelch should open so you hear the 1,000-Hz tone;

- Set the knob for maximum squelch (no background noise);

- Increase the signal to 30 microvolts. The squelch should **not** open; and

- The squelch should open when you increase the signal to 3,000 microvolts.

Develop Your Own Tests

Of course, the sequence of the tests and the exact figures just given will not necessarily apply to other models. Probably you should make some variations to accommodate different designs. But, **do use a system of testing**, and don't depend on hit-or-miss methods.

Only methodical tests and correct wiring of good test equipment can provide the accuracy and repeatability necessary for profitable repairs without complaints. □

Making a "CLEAN" sale

By Shelby Henle

Editor's Note: Some details of Mr. Henle's story seemed unreal, and I questioned them. However, it appears he has some unusual customers and also unique business methods. He told about the first TV installation he had made 27 years ago, using a yagi antenna mounted 50' above the superstructure of a riverboat nightclub. Some of his customers are

rich ranchers in the Sacramento Delta region. One rancher years ago wanted the best fringe area reception possible for his 27" b-w TV, and the search for a powerful antenna ended with a full rhombic mounted on fence posts! After learning of those experiences, I could believe that the following incidents really happened.

We had made a shop repair on a small portable TV for a new customer. When we delivered it, he asked us to look at his big color console, which was operating poorly on rabbit ears in the master

bedroom of an expensive and beautiful new home.

After we tried in vain to improve the reception, we suggested the installation of an outside antenna. The customer strongly vetoed that

idea. He made us understand that the expensive curved tiles of the roof were sacred and unblemished by the feet of television men. We carefully surveyed possible locations for an antenna, and finally convinced him that we could chimney-mount a good antenna with rotor, without penetrating the virgin tile of the roof.

Before he could change his mind, we left to pick up the antenna supplies. Also, we brought back a large 25" Mediterranean-styled color console, which I thought seemed ideal for the wood-paneled family room. This family room contained a full-sized pool table, a 20-foot rock fireplace, a big picture window along one wall, and a large, handsome wet bar (apparently the pride and joy of the owner). At first, there seemed to be no room for a TV receiver. We explained to the owner that we wanted to show him a really good picture, and he finally gave us permission to locate the new console against a wall adjacent to the bar. Perhaps the spot was not perfect, but it did permit viewing from most areas of the room.

The home owner watched us constantly as we climbed on the roof and carefully installed the antenna and rotor on the chimney. We pointed out to him that not a one of his precious curved tiles was damaged or disturbed, because every step with our soft-soled shoes had been between the tiles.



**Brighten her day
as you brighten yours
with a four-pack of
Perma Power Color-Brite**

PRODUCTS OF  Chamberlain

**Save money now on
a four-pack of
Perma Power C-511
Color-Brite... and get
a beautiful necklace
for her as a FREE BONUS!**

With their colorful beads and liquid silver style chain, nothing will brighten her day like these beautiful necklaces. We've selected a variety of bead styles, so you can get a pattern for each of your girls. You'll brighten your day as you save more than \$1.00 per britener on the britener you use most often. You'll brighten your customer's day, too, because Model C-511 Color-Brite immediately restores sharpness, detail and contrast to faded color picture tubes. And they fit most sets.

Offer valid only while supply lasts. Hurry to your distributor today!



Perma Power

Chamberlain Manufacturing Corporation
Perma Power Division
845 Larch Avenue, Elmhurst, Illinois 60126
Telephone (312) 279-3600

For More Details Circle (9) on Reply Card

Evidently, the owner was becoming convinced that we knew our business, for he agreed rather easily for us to install an antenna outlet behind our color receiver. But when I started to make a hole, he stopped me, and then brought out a huge 3/4" electric drill with a wood bit.

"Let me drill the hole, I want it done right, and without a mess." "Perhaps you should let me use my small drill; that is part of my job."

"No, it's my house. Nobody else is going to make a hole in my wall!" "Whrr" went the drill bit, into the wall, and "clank" went the copper water pipe, as water spurted all over everything.

The customer, red-faced and almost apoplectic, turned to me and said, "You would have done the same thing. The pipe was right in the way." Trying not to antagonize him, I replied, "We usually poke around with a long screwdriver to check for obstacles."

"Well, at least I know where to turn off the water. It's a good thing I was here." He rushed to shut off the water, and returned to the bar where he drained the last of a bottle, all the while expressing his displeasure in no uncertain terms.

We went to work to mop up the mess, and to wire in an antenna tap with a cover to make a neat appearance, much like an AC outlet.

Later, we all relaxed in comfortable chairs, enjoyed the hospitality (the owner now was pleasant), and demonstrated beautiful color TV pictures on Channels 2, 3, 4, 5, 6, 7, 8, 9, 10, 12, and 13. As we were showing the customer how to operate the controls of the TV, we overheard the lady of the house telling someone on the telephone that "Santa Claus" had brought them a lovely pecan-wood color receiver for Christmas. Also, we noticed that she had made the TV an integral part of the room by placing large cushions all around the base to protect it from the shoes of anyone who might come to the bar.

The time was right, and he

signed our invoice without any remarks. To head off the possibility of a trade-in, I offered to run wires to the console in the bedroom and a portable in the kitchen. But Mr. Do-It-Himself decided to accept 200-feet of lead-in, so he could play around with it later. We explained

he should not merely parallel the extra leads, and he promised to ask our advice when the time came.

Did the unfortunate episode with the punctured water line help or hurt the demonstration? I don't know, but with all that water, we certainly made a "clean" sale. □

TV Tuner Service Systems

Now you can service and align all TV Tuners . . . VHF & UHF . . . all types.

Provide TV Tuner Service in your area . . . expand into a new professional business.

• Professional TV Tuner Testing Equipment • Laboratory accuracy • Production line durability • Equipment used by the manufacturer in tuner production and test • Furnish high level, accurate signals needed to test, align or analyze TV Tuners.

TIC Model 1212 VHF Sweep Generator Sweeps each VHF channel (2-13) with crystal controlled pulse markers for video and sound carriers. Plus 40 MHz i.f. position for Ch #1 (UHF) of tuner or color TV i.f. alignment.

High level output (0.5v). Variable attenuator (80 dB). Inbuilt detector system for Network Analysis. \$400.00

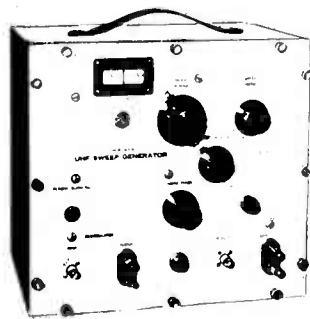
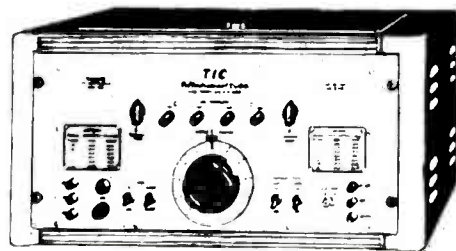

RCA Model WR41B UHF Sweep Generator Tunes the UHF TV band (470-890 MHz). High level output, variable sweep width, built in attenuator (100 dB). \$285.00

Telonic Model S3 UHF Sweep Generator

Tunes the UHF TV band (470-890 MHz). High level output, wide sweep (variable), built in attenuator. \$200.00

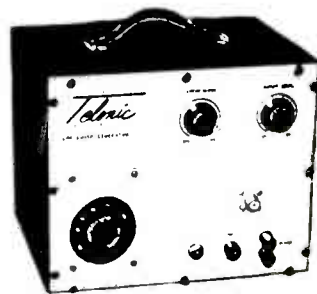

Instruments are used, professionally reconditioned, calibrated and guaranteed. Quantities limited.

Do not confuse with TV Service type equipment; this is production quality instrumentation, built to operate day in - day out . . . with laboratory accuracy.

Complete TV Tuner Service Systems available, write for details and lists of auxiliary equipment.

WESTERN INSTRUMENTS 5714 N. Western Ave., Chicago, Illinois 60659
(312) 728-1801

For More Details Circle (10) on Reply Card

Servicing GE Modular Color TV



Part 2/By Gill Grieshaber, CET

How many low-voltage supplies does the GE 19YC2 chassis have? What are the voltages, and where are the components located? How does a zener and a transistor regulator operate? These questions are answered this month.

Power Supply

Some power supply components of the General Electric 19YC2 chassis are shown in Figure 1. Line voltage enters through a polarized plug on a plastic bracket. The larger of the two power prongs connects to the chassis and common ground of the TV; so, if the wall socket is wired correctly, the chassis actually is wired to earth ground. However, all of the usual insulations for "hot chassis" receivers are supplied, to make sure no customer can receive a shock. There is no power transformer, but a heater transformer is supplied for the picture tube.

Of course, you should operate the receiver from an isolation transformer, or be **very** certain that the chassis side of the AC line is grounded, before you examine the chassis with the back removed, or attach any test equipment. One more safety precaution: make sure the power cable is unplugged (not just turned off at the switch) before you reach into the tight corners to remove a module.

We will list the module numbers as they are covered. However, neither the GE literature nor Photo-

fact features them. One reason is that the original and the warranty replacements sometimes have different numbers. Later, we'll give you a complete list.

Main Power Supply

Figure 2 shows the main power-supply circuits. One 4-ampere line fuse and a 1-ampere B+ fuse furnish the protection. Degaussing operates from a Positive-Temperature-Coefficient (PTC) resistor (R902). When the power first is applied, the resistance is low and the degaussing current is strong. Power dissipated across the PTC resistor heats it and the resistance increases until the current becomes negligible. During times the power is turned off, the resistor cools and is ready to repeat the degaussing cycle.

Finding The Voltages

This model has many voltage supplies, as is common for transistor operation. The voltages actually measured in the sample under test will be listed, rather than those given on other schematics.

These are the DC-voltage sources:

- The principal voltage is +139 volts

obtained by single-diode rectification of the line voltage. It can be measured at the 1-ampere fuse;

- +125 volts comes from +139 volts; it is for the audio-output transistor, and can be measured at the output transformer, behind the heat sink;

- There are two 22-volt supplies. The light-duty one is regulated by a zener diode, and the other is regulated and current-limited by transistors (it will be described later);

- +195 volts is obtained by rectification of horizontal pulses, which rides on the +139-volt DC supply; and

- a +33-volt supply from rectification of horizontal-sweep pulses.

In addition, there are two low-voltage sources obtained by rectifying horizontal pulses. But, these are mounted on the vertical module and will be covered with the vertical circuit.

Heavy components, such as the heater transformer for the CRT, the filter choke, and the 3-section can-type electrolytic filter capacitor, are mounted on the chassis frame, as are several of the high-wattage resistors. Notice, in Figure 2, that

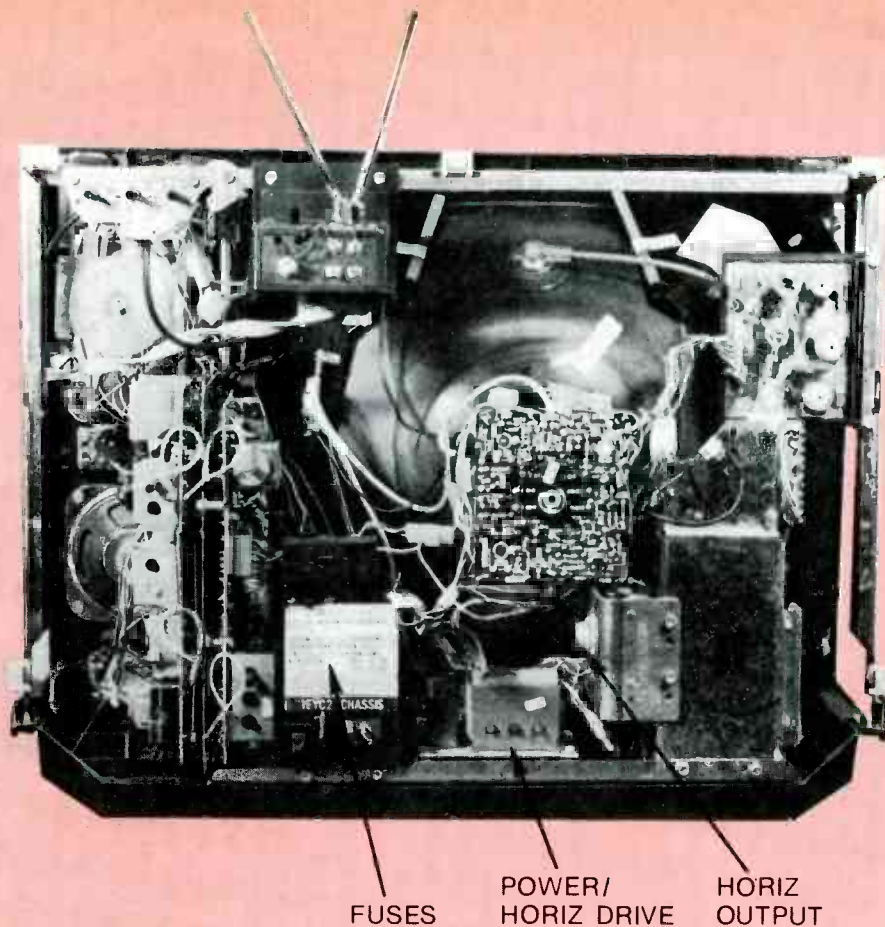

Fig. 1 Locations of some power-supply components are shown here.

the main rectifier for the +139-volt supply (Y912), its bypass capacitor (C912), the zener diode (Y916), and the bypass capacitor (C918) are all mounted on the power-supply/buffer module.

Also, on the module are the transistors, diodes, and capacitors for the regulated/limited 22-volt supply, extra connectors that distribute horizontal pulses from the flyback to various circuits, and the horizontal-buffer transistor and driving transformer which feed the horizontal-output transistor. Many of these components are pointed out in Figure 3.

Supply Regulation

Before describing in detail the regulation of the +22-volt supply, it might be helpful to analyze the basic operation of such regulators.

Zener regulation

A simple "zener-regulated" supply is shown in Figure 4A. Normal diode rectifiers pass current when the anode is more positive than the

cathode, and have virtually no current flow when the anode is negative relative to the cathode. Of course, if you were to increase the reverse voltage applied to a normal diode, eventually a voltage would be reached where the diode would "avalanche". That is, it would draw a heavy current, and because a conventional rectifier circuit has no provision for limiting the current, the excessive current would destroy the junction in a fraction of a second.

Zener diodes do the same thing, but they are designed to give stable voltages when operated in the avalanche mode, and the circuits provide current limiting. The usual schematic symbol for a zener is the same as for a normal solid-state diode, but with both ends of the cathode line bent to indicate non-linearity.

The voltage rating of a zener diode is the reverse voltage drop across it at the rated wattage (current times voltage). Over the useful range of regulation, the

zener voltage might vary as much as $\pm 5\%$.

Back to Figure 4A. R1 limits the maximum current, and also makes the regulation poor, so the changes of zener current can improve the regulation as the zener acts as a non-linear resistor. Voltage changes across a zener vary the current far more than the same changes would vary the current through a linear resistor, such as a wire-wound type, for example. Let's say a voltage increased 10%. Current through a linear resistor would rise 10%, but current through a zener might increase 20% or more. This extra current has the effect of partially stabilizing the voltage across the zener. The voltage changes, but only about a third as much.

Now, we add the load, symbolized by R2. In practice, R1 is chosen so that the current through the zener does not exceed the rating when the current through R2 is at a minimum. Let's assume that the circuit has been correctly designed and is operating normally.

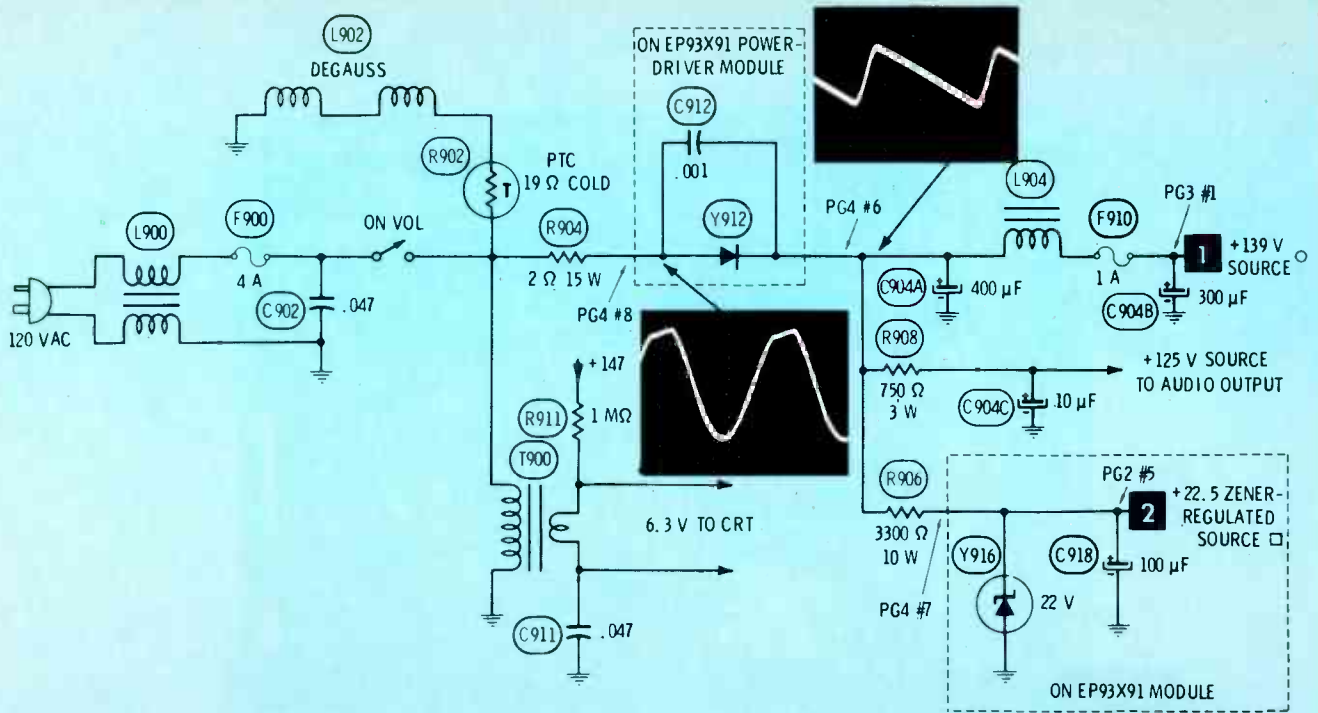

Fig. 2 One diode (Y912) rectifies the power-line voltage; others operate from horizontal-scanning power. A heater transformer for the CRT is supplied, but no power transformer. Those components enclosed in dotted lines are on the power-supply/horiz-buffer module. Others are on the power/fuse bracket, or mounted on the chassis frame. The positive peak of Y912 anode waveform is flattened because of the voltage drop across R904.

If the load (R2) changes and draws less current, the voltage at the zener increases. But the increased voltage forces the zener to draw more than a linear amount of current. Therefore, most of the voltage increase is cancelled by the added zener current.

On the other hand, if the load current increases, the zener voltage goes down, along with the extra amount of zener current, and the

voltage drop is minimized.

Did you notice that the voltage is stabilized by keeping the sum of the zener current and the load current nearly constant? Of course, when the load current increases until the zener current is nearly zero, all regulation is lost, and the voltage drops rapidly with more load.

By the way, substituting a replacement zener of a higher wattage

than the original often produces poorer regulation.

Transistor regulation

Regulation by means of a series-wired transistor operates because of two principles: (1) the transistor acts as an "emitter follower" (that is, the emitter follows any change of base voltage, but the emitter impedance is lower, so there is a power gain without a voltage gain);

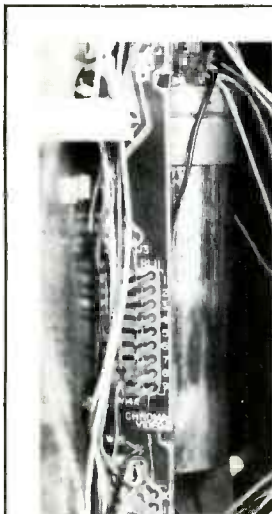

The 3-section filter-capacitor can is mounted in front of the connectors for the chroma/video module.

On the chassis frame in front of the input/power bracket are located the filter choke, and the heater transformer for the picture tube.

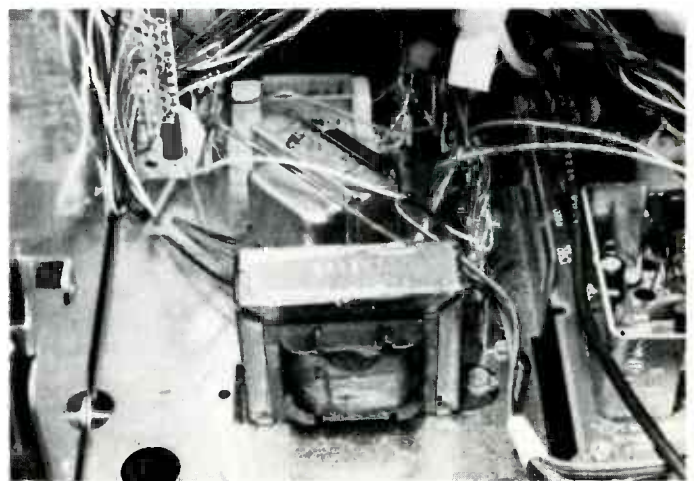

and (2) a change of emitter-to-ground voltage affects the transistor bias in exactly the same amount as an equal change of base-to-ground voltage. (Of course the effect of the voltage change is reversed; an increase of base voltage equals a decrease of emitter voltage.)

Look at the simplified schematic of Figure 4B. The base-to-ground voltage is supplied by a battery to make certain it will not vary. Now, when the power first is turned on, the emitter voltage supplying the load is zero, and the base voltage is positive by several volts (both relative to ground). Of course, this is extremely high forward bias, and the transistor will draw a large current, raising the emitter voltage across R2. If the emitter voltage were to rise up equal to the base voltage, the C/E current would stop, because it would represent zero B/E bias. Instead, higher emitter voltage allows less current flow, until it stabilizes with the

emitter about 0.6 volt less positive than the base.

Just remember that a change of emitter voltage affects the bias and current **opposite** to the same change of base voltage. In other words, **an increase of emitter voltage is the same as a decrease of base-to-ground voltage.**

Let's take an example. Suppose the battery measures 12 volts, and the emitter voltage across the load is stabilized at +11.4 volts, making a bias of +0.6 volt. An increase of load current will reduce the emitter-to-ground voltage, but that is an increase of forward bias, so the transistor draws more current, thus bringing the emitter/load voltage back nearly to the original value.

In an opposite action, a decrease of load current increases the emitter voltage, producing less forward bias, which decreases the C/E current and reduces the emitter voltage to almost the starting value.

To sum up the operation: the

transistor C/E junction acts as a **variable loss resistance**, supplying more or less current as needed to stabilize the emitter voltage just 0.6 volt lower than the base voltage. With the base voltage supplied by a battery, the emitter voltage should not change more than about 0.1 volt as the load current varies from nearly zero up to the maximum current capability of the transistor! That is excellent regulation.

It's not practical to include a battery in a TV receiver, so a zener regulator stabilizes the base voltage fairly well (Figure 4C). The complete circuit has two regulators. The zener regulates the base voltage, and the base voltage stabilizes the emitter voltage.

Although the degree of regulation from Figure 4A circuits is about equal to those of Figure 4C, many more of the zener-transistor combinations are used in new models, especially when the load is heavy. That's because it's a **series** circuit,

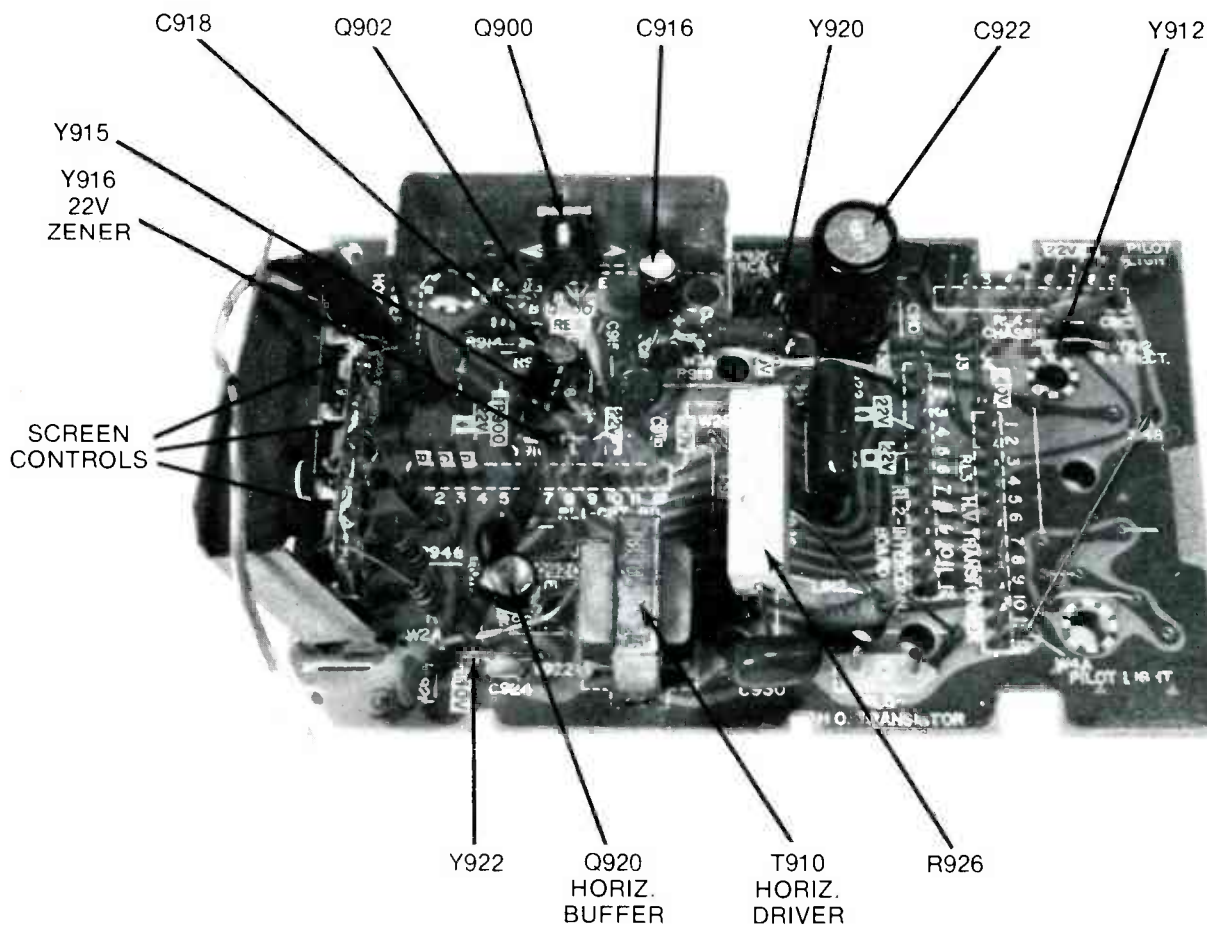

Fig. 3 Some components of the EP93X91 power-supply/horiz-buffer module are identified by arrows.

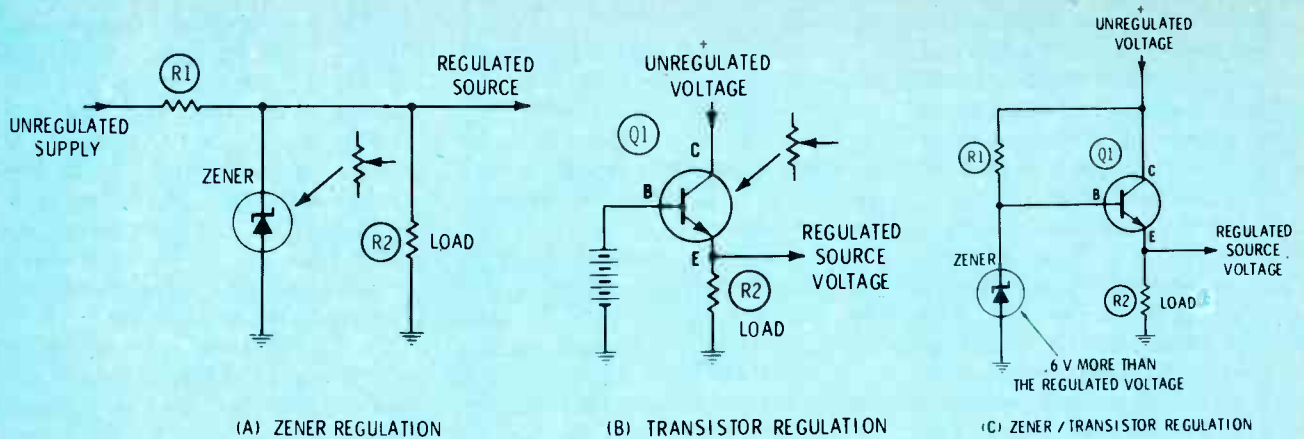

Fig. 4 These are 3 simplified regulator circuits. (A) Zener diodes try to stabilize the DC voltage across them, when a reverse voltage is applied. This is a shunt-type regulator, and it does waste some current. (B) Many transistor regulators actually operate as emitter followers. The transistor tries to maintain an emitter voltage just 0.6 volt lower than the base voltage, stabilized here by a battery. (C) Many regulators have this approximate schematic. The base voltage is stabilized fairly well by a zener shunt regulator, then the transistor attempts to keep the emitter voltage just slightly lower than the base voltage. Changes of emitter voltage are bias changes of the same importance as base voltage changes.

whereas the zener is a parallel one. Parallel regulators waste some current, and that's important when the power comes from rectification of horizontal-sweep pulses.

General Electric regulation

The +33 and the +195 voltage sources are shown in Figure 5, along with the regulated and current-limited +22-volt source. The first two do not require a comment just now, so we will analyze the regulated one.

Voltage for the 22-volt supply comes from the +33-volt source, but the 22.5-volt zener supply which stabilizes the base voltage of Q900, the regulator, is powered from the +139-volt main power supply.

Without the current-limiting feature, the base of Q900 would connect direct to the +22.5-volt zener-regulated supply. However, diode Y915 disconnects the base of Q900 from the regulated supply when the load current is excessive. Here's how it works.

Base bias for Q900 comes from the +139-volt supply through R918 and R916 (the collector of Q902 connects between them, but it is cutoff now). Without Y915, the bias voltage could be higher than the 22.5-volt supply, so Y915 conducts, clamping the bias to the 22.5-volt supply. The 0.7-volt drop across

Y915 added to the 22.5 volts provides +23.2 volts to Q900 base. Of course, the emitter of Q900 is always about 0.6 volt less positive, making the regulated voltage stabilized at +22.6 volts. Normal current of the +22-volt supply produces a voltage drop of about 0.3 volt across R914. And R914 is between base and emitter of Q902 limiter, so the 0.3 volt is bias, but not enough to cause any collector current in Q902. (In normal operation, Q902 does nothing.)

Now, assume an excessive current drawn from the +22-volt source. Voltage drop increases across R914, thus increasing the forward bias of Q902, and causing Q902 to draw some collector current. Increased collector current lowers the base voltage of Q900, and when it nearly reaches +22.5 volts, Y915 opens, so the base voltage no longer is clamped. Any increased current on the 22-volt source forces the Q900 base voltage to decrease sharply.

The Q900 emitter voltage follows the falling base voltage, and the +22-volt supply voltage falls to whatever amount limits the current to a safe value.

As a test, a 48-ohm resistor was paralleled across the 22-volt supply. The voltage dropped to only 11.4 because of the extra 240 milliamperes of current. Q900 ran warm, but nothing blew. Without

the current-limiting function, the extra current would have been about 450 milliamperes.

Out of curiosity, I compared the regulation of the zener-regulated supply against the zener/transistor supply when the line voltage was decreased. When the +139-volt supply decreased 9%, the zener-regulated +22.5-volt supply decreased 3.1%, while the output of the Q900 regulator dropped only 2.9%.

Scan Rectification

Because of the non-symmetrical waveform, rectification of horizontal-sweep AC voltages has some peculiarities. These were explained in the September, 1975 *ELECTRONIC SERVICING* article: "Scan Rectification...How Is It Different?" Some of that information will be repeated here.

Any rectifier operates on the voltage from the zero-voltage line to the positive or negative peak of the waveform. Whether the positive or negative peak is rectified depends on the polarity of the rectifier. Further, peak-reading rectification operates on the highest amplitude of that peak, relative to the zero line.

In Figure 5, both the +33-volt and the +195-volt sources are obtained by rectification of pulses from the horizontal-output trans-

former. Both pulse signals are negative-going, and one is 270 VPP, while the other is 480 VPP, respectively. If all conditions were equal, the +195 voltage should be only +58 volts. Why the difference of voltage?

The waveforms of Figure 6 can be used to explain it. Waveform (A) is the one at the anode of Y914. The zero-voltage line was placed accurately by a dual-trace scope, and the diode polarity is correct for rectification of the positive peak (this sometimes is called "scan" rectification because that part of the waveform occurs during the time the electron beam scans across the picture tube). Obviously, the DC voltage cannot be very high, if the smaller positive peak is used.

The waveform in (B) is similar, but the zero-voltage line is below the center. Rectification of this larger positive peak should (and does) produce a much larger DC output. The difference is that this waveform comes from a flyback winding that also includes the +139-volt source voltage. The AC signal is riding on top of +139 volts.

Another way to look at it is to say that the +139 volts and the +58 volts from rectification are in series, together totalling +197 volts.

Ripple from these "scan rectification" voltage sources has a different waveform than ripple from power-line rectifiers. Two samples are shown in Figure 7. The top trace is the 0.4-volt peak-to-peak ripple at the output of the +22-volt regulated supply. I'm not sure at this time where the horizontal pulses

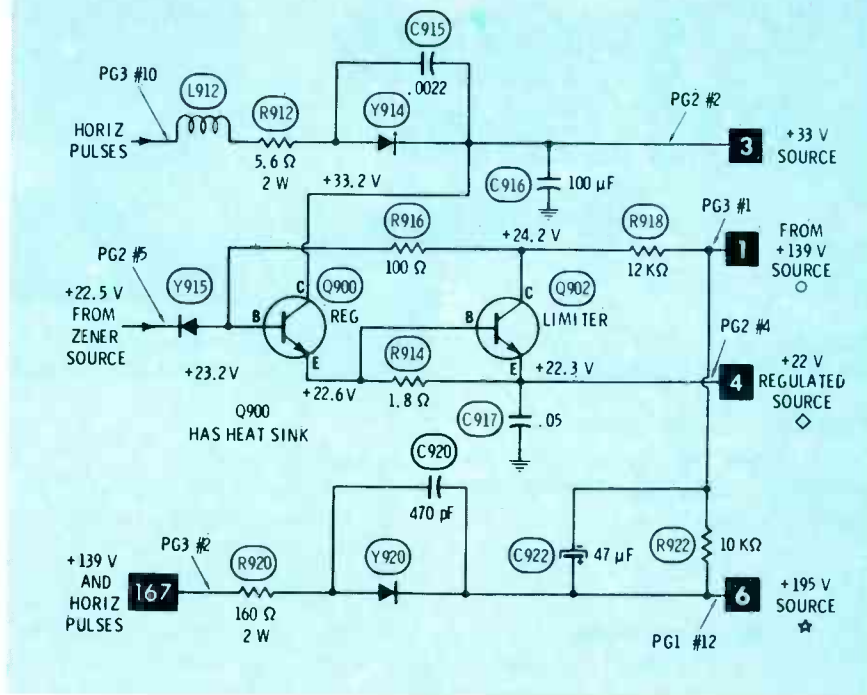

Fig. 5 These three voltage sources are located on the power-supply module. Notice that all three receive their power from the horizontal-sweep circuit, although the regulated source is stabilized from the +22.5-volt source, which is powered from the main B+ source.

originate. It's not capacitance pick-up by the scope probe of signal radiated from the horizontal circuit.

Shown by the lower trace is the 3-volt PP ripple at the cathode of Y920, the +195-volt rectifier. Output of the +33-volt source is similar, but it has an upward bow in the center of each scan portion.

These waveforms illustrate a good tip: **do NOT use conventional 60-Hz power-line type of rectifiers to replace any diodes which rectify**

horizontal sweep pulses, or which pass horizontal-blanking pulses. Instead, install only recommended substitutes or exact replacements, suitable for fast switching.

Next Month

Circuits and waveforms of the horizontal-phase detector, horizontal oscillator (some surprises there), horizontal buffer, horizontal output and high voltage will be detailed next month. □

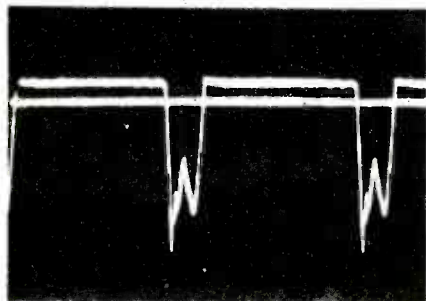

(A)

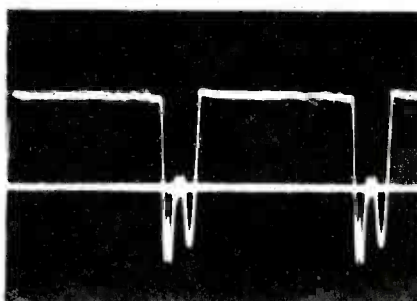

(B)

Fig. 6 An analysis of these DC waveforms will explain why one has so much higher DC voltage from the rectifier. (A) This 270-VPP waveform is the conventional one; it is found at the anode of Y914. The zero-voltage line is in the correct location for a pulse voltage of this duty cycle and when no DC voltage is mixed with the waveform. (B) When +139 volts is mixed with a 480-VPP waveform, the zero-voltage line is moved down (actually the waveform is moved higher). Then, rectification operates on the larger positive peak from the zero line to the top, producing a higher DC voltage than in (A).

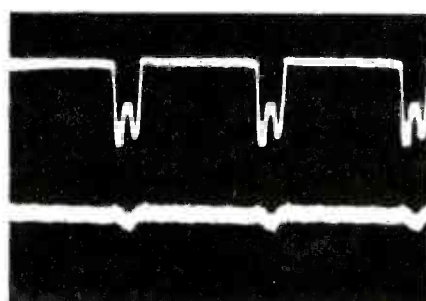

Fig. 7 The ripple waveforms are not sawteeth or filtered sawteeth when horizontal signals are rectified. The top trace shows the unexplained 0.4-volt horizontal pulses at the output of Q902, the 22-volt regulated DC-voltage source. Typical of the output ripple from Y914 and Y920 is the bouncing waveform at the bottom.

SERVICING ELECTRONIC ORGANS



Part 4
By Norman H. Crowhurst

Defects that can cause a single organ note to be wrong are analyzed, and troubleshooting tests are given.

One Bad Note

There are four main ways that a single organ note can misbehave:

- The note does not sound;
- The note speaks all the time the organ is on, even when the note is not pressed (sometimes this is called a "cipher");
- It might play out of tune (wrong frequency); or
- The volume or timbre might be different from its neighbors on the keyboard.

In addition, we might add erratic or intermittent operation, and spluttering, warbling, or noisy sounds. If the stop has gradual attack or decay characteristics, the defect might make the attack in-

stantaneous (perhaps with a click or thump), or the decay might stop too soon.

Note does not play

Regardless of the type of organ, only two fundamental problems can keep the note from sounding: the keying device for the note; or the tone source of the note. If you know the organ circuits thoroughly, it's likely you can determine by some simple tests from outside the organ which defect is responsible.

For example, most organs have several key switches under each note, and usually two or more switches will be for different octaves. Suppose the note that will not speak is B-flat below middle C of the 8' pitch. Then turn off the 8' and turn on the 4' pitch and try the B-flat an octave above. If it works normally, you have proved the tone source is okay (regardless of whether it's an oscillator-divider or individual tone source type).

Next step is to determine if the problem is in the switch or in a

gate that's operated by the switch.

Before we go on, I must mention the newer models which have only one switch contact under each key. If the note does not sound with any pitch or tone stop, then it's certain the contact is bad. But if only one note of one octave or tone stop is dead, then a gate is at fault.

Figure 1 shows simplified schematics of indirect and direct keying. With indirect keying, the actual key switch changes some voltage that's applied to the gate (such as bias for a transistor, or keying voltage to a diode), and the gate allows the proper audio tone to pass through to the common audio bus.

Direct keying closes a normally-open switch contact to pass the audio to the common-audio bus. Or, a normally-closed switch (which has grounded the audio coming through isolation resistors) opens to allow the audio to go on to the common output.

Sometimes the defect of the keying switch will be obvious. Intermittent operation, or a scratching noise at the beginning or ending of a note, indicates a corroded or worn contact. If the spring contact has taken a "set" and is not closing tightly enough, the remedy might be just an adjustment of the spring. A few models have "bus bar shifters", allowing the common bus to be moved to one side, exposing an unused part of the keying bus.

Unless the service information says otherwise, the keying switch should be set to make contact when the keyboard note is depressed halfway. Of course, you can insert a small screwdriver blade between the two switch contacts as a test. If the note sounds, but does not when the key is pressed, this is proof of a bad key switch.

Key switches often are hidden and thus difficult to reach for test or adjustment. That's why you should attempt a diagnosis before exposing the contacts.

Some models use a combination of direct and indirect keying (the indirect provides special attack or sustain functions). This gives another way of analyzing contact-switch versus generator failures.

Machines that have master oscillators followed by dividers to provide lower octaves make possible another kind of diagnosis. If a

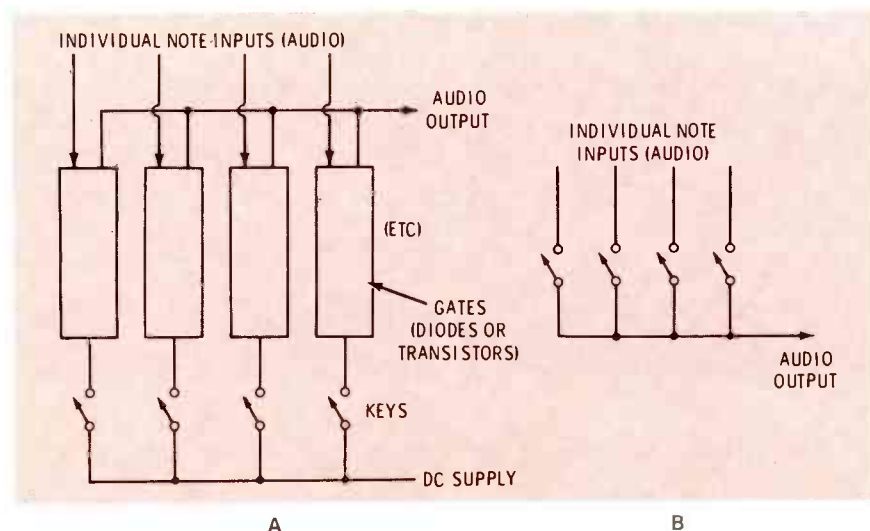

Fig. 1 Audio from the tone generators either is keyed by some kind of gate (A), or directly by the key switches (B). A DC supply is required to operate the gates, which might be diodes, transistors, neon bulbs, or tubes.

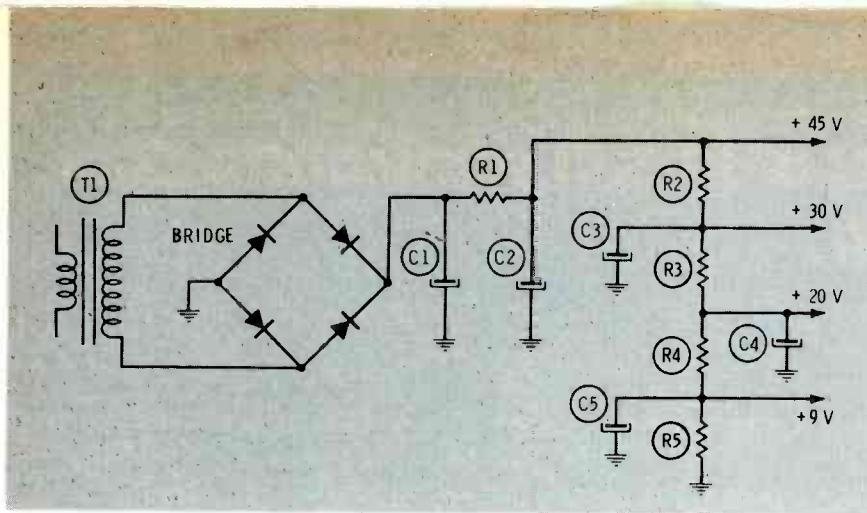

Fig. 2 Some power supplies furnish voltages for the power amplifier, as well as for the oscillators and gates, by means of a voltage divider.

divider is dead, then not only it but all other notes of the same name below it are dead also. For example, suppose "G" of the middle octave is dead because of a divider defect. It will be dead (sometimes it gurgles or plays an octave high), and all the "G" notes below it also will be dead.

If you know the types of generators and keying, there should never (well, almost never) be any doubt about which is causing the dead note.

DC-voltage supplies

Organs that key a DC voltage, rather than the audio, require a DC power supply, often with several different voltages. In some cases, the various voltages come from a multi-tap voltage divider (Figure 2). Defects in the circuits supplied by one voltage (or defects of the voltage divider itself) can affect the other voltages. For example, if R3 opened, the +45 and +30 voltages would increase, and the +20 and +9 voltages would measure zero.

Indirect keying, which requires DC voltages, normally is used when a slow attack or a sustain (the note dies away gradually after the key is released) is desired. Therefore, problems involving one DC voltage and not the others might affect only the time of the sustain.

Regulated power

Other power supplies have regulators for some of the voltage sources, as shown in Figure 3. Some variations of the zener/transistor circuit of Figure 3B are used most often.

Transistor failures probably account for most regulator malfunc-

tions. A C/E short in the transistor or an open zener diode increases the DC output voltage, which does not silence the organ unless the higher voltage triggers other failures. An open transistor or a shorted diode eliminates all of the regulated voltage.

The transistor should be removed for testing. While it is out, check the base-to-ground voltage. If the resistor and zener are okay, the base voltage should be the same as when the regulator is working. Also, check the regulated line for shorts which could have blown the transistor.

Of course, failures of the power supply do not merely eliminate one note. All notes, or all sustain functions, would be affected. It is possible that excessive current in the oscillator for one note started the power supply failure, and that possibility should be investigated. Every note of every pitch should be tested, following the power supply repair, to make sure all operate correctly.

Note Plays Constantly

One note that plays all the time an organ is turned on is called a "cipher" in pipe organ terminology. When the audio is keyed directly, this means the switch contact is not opening. Usually a bending of the contact spring is required. (We mentioned before how hum can seem to be a "B-natural" note, so don't let hum fool you.)

You should have little trouble finding which note is stuck. Just try the keys one at a time until the two pitches become nearly the same. Finally, you should find one note that makes no difference whether

the key is depressed or not. That's the bad one. Of course, if the stops include different octaves (8', 4', etc.), you should try one at a time until the cipher is found.

When a contact needs re-setting, notice the appearance and the action of adjacent notes, and adjust so the bad one closes and opens the same.

If the keying is done by DC control, a note that plays constantly indicates that whatever is used as a gate (diode, transistor, neon, or whatever) is defective in some way so the DC no longer controls it. Of course, the key switch might be stuck or shorted. The best test is to see if the control voltage reaches the gate only when the key is operated or not. If it's there all the time, the switch is shorted.

A shorted gate device might overload the power supply and result in a blown fuse. But it also would stop anything else that operates from the fuse. Never replace a fuse with one of a larger amperage rating. And don't substitute a fast-blow type for a slow-blow variety; otherwise, it might blow during operation with many notes or from fast arpeggios. Or, a fast-blow type might go bad if someone turns the power switch on and off several times, as a child might do.

Diode keying

Figure 4 gives the schematic of a typical keyer using diodes as gates. Negative voltage is applied to the anodes of both diodes from the negative bias bus. Therefore, both are open circuits, and the audio signal cannot pass through them. When a key is pressed, positive voltage from the positive keying bus overrides the negative voltage, making the anodes positive. Both diodes now conduct, and the audio from the tone source goes on to the amplifier.

Of course, there must be one of these circuits for each note that is keyed in this way.

An open in either diode would prevent the note from speaking. Either diode shorted probably would allow the note to be heard at reduced volume when it is keyed, or it might sound softly all the time.

Distortion?

If you are well-trained in electronic theory, you might question

Now you can stock only 300 semiconductors instead of 112,000.

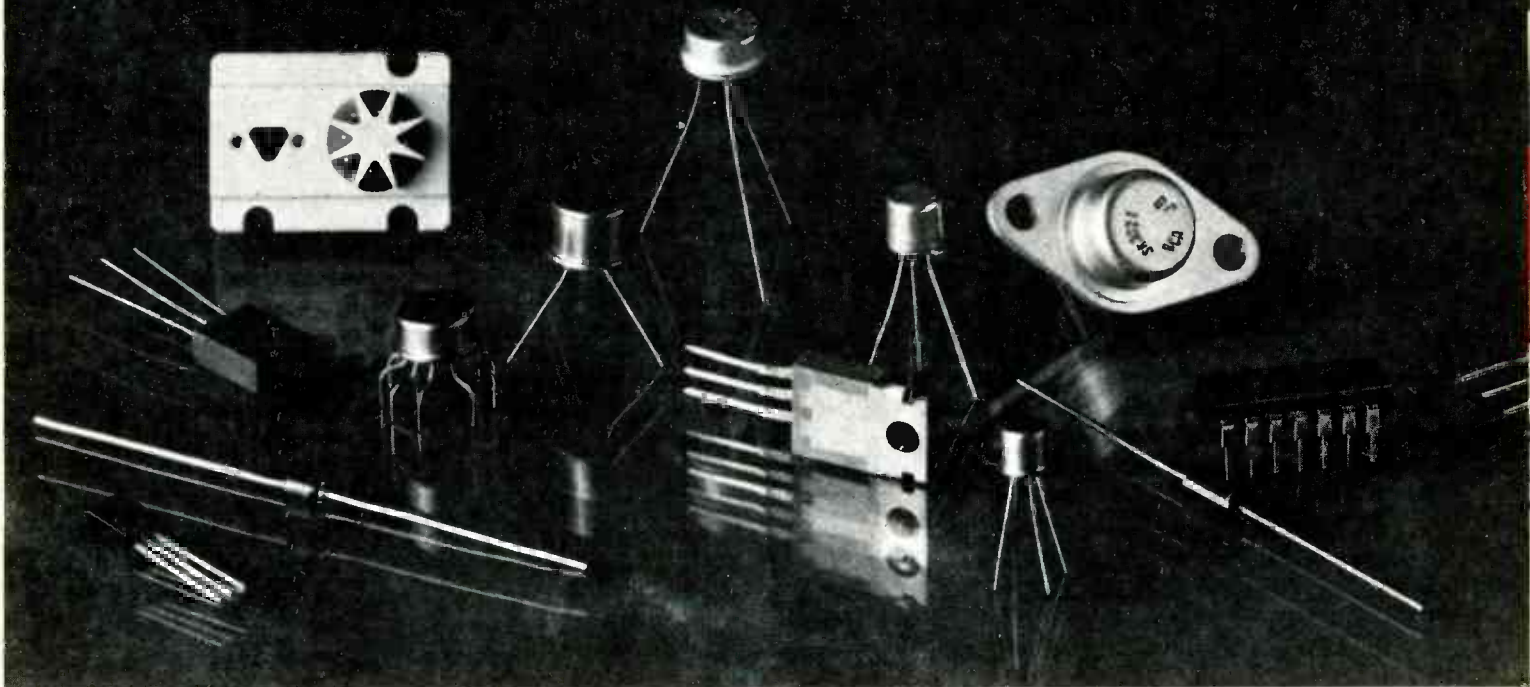

diodes used as audio gates. An open or a saturated diode can be used in audio circuits without introducing any clipping type of distortion. However, during the time between those conditions, a diode can and does clip part of the waveform. In diode-keying circuits, the transition between on and off has been slowed to remove pops and clicks; so, during those times, the diodes cause some distortion.

Such distortion here is of no consequence, for two reasons. First, it occurs only at the start and ending of each note; and many pipe organs have an acoustic equivalent of this distortion. The momentary bits of distortion add a welcome variation from the electronic monotony.

Also, the distortion affects **only** one note. This is an important distinction. Distortion of a single note changes the waveform and adds harmonics; the timbre of the note is changed. But severe distortion when **more than one** is present produces sum-and-difference frequencies, and the sound is intolerable.

To sum it up: deliberate distortion added to individual notes to produce a certain tone quality is very desirable. However, distortion in an amplifier that handles many notes must be considered a defect needing repairs.

Transistor keying

Transistors often are used to key individual notes. One such circuit is shown in Figure 5. Again, there are several bus circuits common to all similar keyers. When the key switch is open, a resistor to the positive bus applies a reverse bias to the PNP transistor to cut off all gain.

Closing the key switch applies enough negative voltage to overcome the positive and provide normal negative bias relative to the emitter. During this time the transistor has normal gain. The output signal is developed across a collector resistor that is common to all the other keying transistors, and it is sent on to the stop switch from there.

Values of the two base resistors, the base bypass capacitor, and the voltages from the two busses deter-

mine the attack and decay times. In fact some models use a stop switch to change voltage or capacitance, and thus lengthen the decay time so it becomes percussion.

Failure of the transistor is the most likely defect in these circuits, although an open resistor occurs sometimes. Test the transistor with an ohmmeter in-circuit by comparing the readings of the bad keyer with those of other normal keyers. If the condition is questionable, remove the transistor for a more-accurate out-of-circuit check.

One Sour Note

An organ that needs tuning, but has no real defect, usually will have several notes out of tune. And some of these probably are so near the correct frequency that only careful listening will reveal them.

However, if just one note (or all the notes of the same designation; that is, all "G", "A#", or whatever) is far out of tune, and the others are okay, then the problem is a parts defect, and not merely tuning.

In organs having separate oscillators for each note, the oscillators



With RCA's SK Series you need stock fewer different semiconductors than you'd have to with any other major brand. Because our 300 devices can replace 112,000. And they're all immediately available.

OEM Quality. You don't have to be concerned about quality with RCA SK's. They measure up to strict AQL Standards to protect you from time-wasting callbacks. Lets you make more calls. And more profits.

See your RCA Distributor for a copy of the new RCA SK Replacement Guide. Or send \$1.00 to RCA Distributor and Special Products Division, P.O. Box 85, Runnemede, N.J. 08078. Phone: (609) 779-5735.

RCA SK Replacement Semiconductors

have a tuned circuit consisting of an inductor and a capacitor in parallel. Either the inductor is variable by a movement of part of the core, or a capacitor which is only a fraction of the total capacitance is in series with a variable resistor (the resistor is varied to change the tuning).

As you probably know, potentiometers (variable resistors) do become noisy and intermittent in audio equipment and TV receivers. Sometimes one opens completely. If the tuning pot for an oscillator

opened, the note would be a semitone (or more) sharp. Shorted turns in the inductor probably would lower the "Q" enough to stop the oscillation.

Organs with master oscillators and dividers have different symptoms. The dividers usually either operate okay or they quit entirely. However, some Baldwin dividers thump intermittently when the time constant increases to where division just barely takes place.

If the master oscillator is off frequency, all the lower-octave notes

of that name will be wrong by the same amount. A dead divider kills all the dividers below it.

Single-oscillator dividers

Some latest-model organs have just **one** master oscillator, not 12. Starting with a frequency such as 3 MHz, digital circuits using IC's develop the 12 equally-tempered notes of the organ's top octave. Then, 12 sets of conventional dividers supply all of the lower notes.

One advantage of such a system

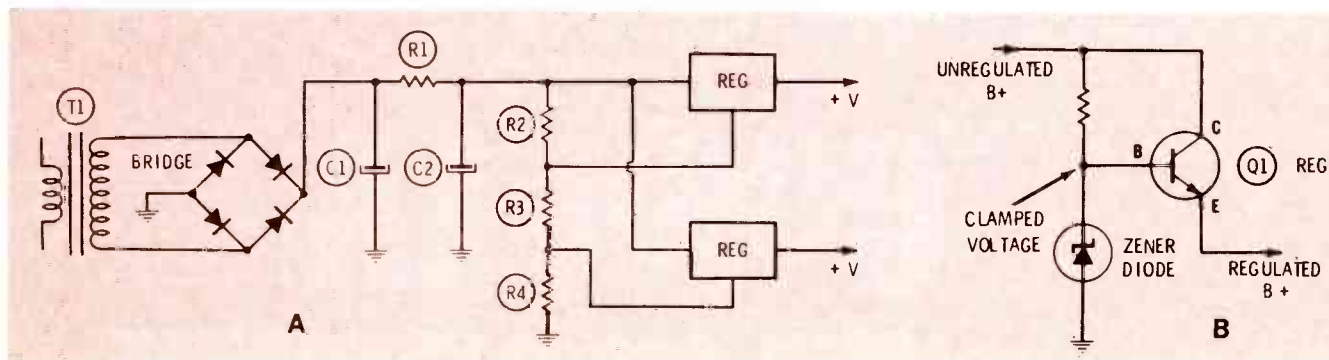

Fig. 3 Regulation of some voltage sources improves both the regulation and the filtering. In schematic (A), the regulator circuits are shown by boxes, while (B) gives a typical series-transistor regulator circuit.

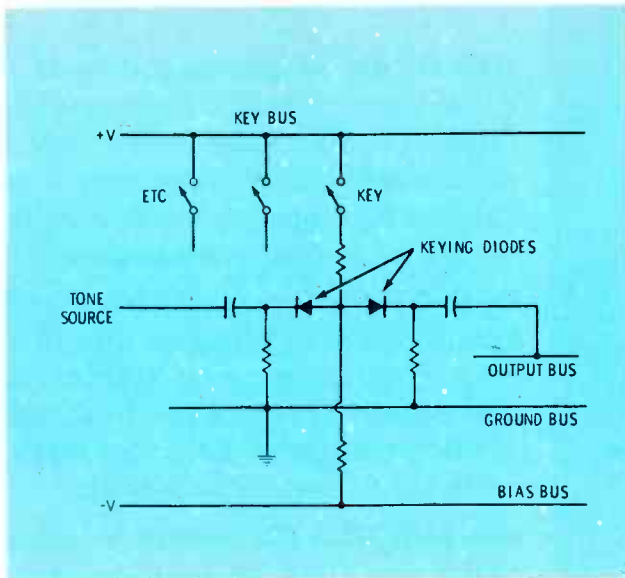

Fig. 4 Double diodes are often used as keying gates. When the key switch for a note is not closed, the diodes have reverse bias (negative voltage to the anodes). Positive voltage is brought in through the key switch to the anodes, making the diodes act as a very low resistance.

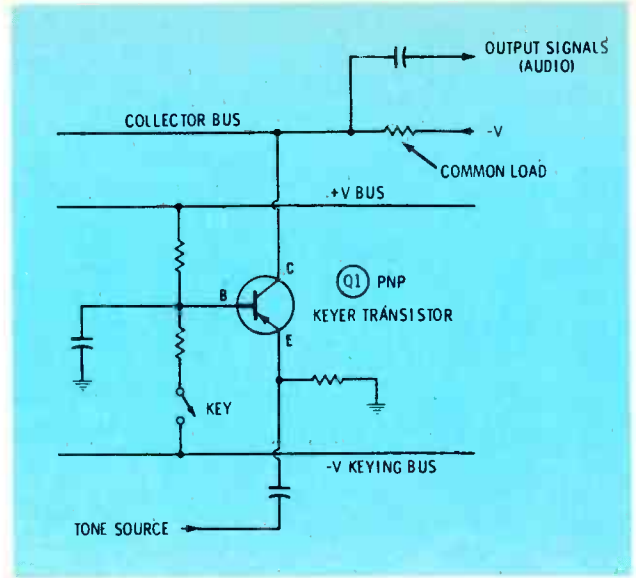

Fig. 5 Bias keying of a transistor gives clickless keying and can provide a long decay for percussion effects. When the key switch is open, the base has reversed bias (positive voltage from the bus), giving zero gain. Operating a key switch brings in negative voltage to supply negative forward bias, which allows the transistor to produce normal gain.

is that only one tuning adjustment determines the tuning of all notes. If someone wanted to tune the organ to another instrument which could not be tuned, or which would be too much trouble to tune, the organ could be tuned in minutes by only one adjustment.

You might assume that no wrong out-of-tune notes could ever be produced by this system. That's not quite right. Look first at the figures in Chart 1. None of the dividers operate by a easy number of divisions, such as a 2, 4, 8, 16, 32, sequence.

Consider the first divider of the chart: it works by a division of 537 to produce the top "F" note. To divide down to 537 requires 8 dividers in a 2, 4, 8, 16, 32, 64, 256, and 512 sequence. But that leaves 25 counts short. So, another 4 dividers add 16 counts, 3 dividers add 8 counts, and finally one more count is added, making 537.

Once every 537 cycles of the 3-MHz "clock" pulse, this divider chain delivers one output pulse of the high "F" note.

Other top notes must be divided by the same complex way. But suppose the LSI chip skips one of the final small counts (say the 8 counts for "F"), then the top note will be flat by 8 Hz. So you see the count could be wrong by any of the

individual dividers. For "F", the mistake might be 1 Hz, 8 Hz, 16 Hz or 25 Hz, if it happened in the final dividers, or more serious errors if a previous divider malfunctioned.

These facts explain how all the "B-flats" or all the "G" notes could have a wrong frequency. But it is not something you can correct, because the problem would be inside an IC chip. Instead the entire chip would require replacement.

Wrong Volume Or Timbre

A single note (or several scattered at random) having too-weak volume, too-strong volume, or a different tone quality from adjacent notes would be caused by faulty isolation resistors or a defective gate.

Models whose dividers emit square waves usually simulate a sawtooth sound by adding 50% 4' and 25% 2' square waves to the 100% level of 8' square waves. This is done by adding isolation resistors to bring in these waveforms from the proper divider. A defect of one isolation resistor would change the volume and tone quality. Each note has these isolation resistors.

Another possible source is a defective keying gate, one having clipping, low gain, or some other problem.

An organ having the stops set for several octaves (where each has a separate keying-switch contact) will exhibit a change of volume and timbre for any note with a switch contact open. One octave of sound will be missing from that one note. The difference is easy to hear, even for non-musical ears. Of course, you can prove this possibility by trying the octaves one at a time. □

| Divider number | Freq A | Freq B | Note |
|----------------|--------|--------|------|
| 537 | 5586.6 | 5584.8 | F |
| 569 | 5272.4 | 5270.7 | E |
| 603 | 4975.1 | 4973.5 | D# |
| 639 | 4694.8 | 4693.3 | D |
| 677 | 4431.3 | 4429.9 | C# |
| 717 | 4184.1 | 4182.8 | C |
| 759 | 3952.6 | 3951.3 | B |
| 804 | 3731.3 | 3730.1 | A# |
| 852 | 3521.1 | 3520.0 | A |
| 903 | 3322.3 | 3321.2 | G# |
| 957 | 3134.8 | 3133.8 | G |
| 1014 | 2958.6 | 2957.6 | F# |
| 1074 | 2793.3 | 2792.4 | F |

Chart 1 This table of divider factors is for an LSI IC chip starting with a 3 MHz master frequency. The frequencies of Column A are obtained when the frequency is precisely 3 MHz. In Column B, the frequency has been reduced a trifle so the top "A" has the concert pitch of 3520 Hz.

LOTS A SHORT CIRCUITS!

by Edmund A. Braun.

Hi there! Got a few minutes? Pencil sharp? Then grab this Pin-wheel Puzzle and start going around together. The last letter of each word is the first letter of the next word. Each correct answer is worth 4 points; a perfect score is 112. It shouldn't be hard to get a high rating except perhaps for someone who thinks "fancy grille" comes from the kitchen of a fancy restaurant, or that "decoder" is a tailor who doesn't make pants or vests! Ready? Then start circling!

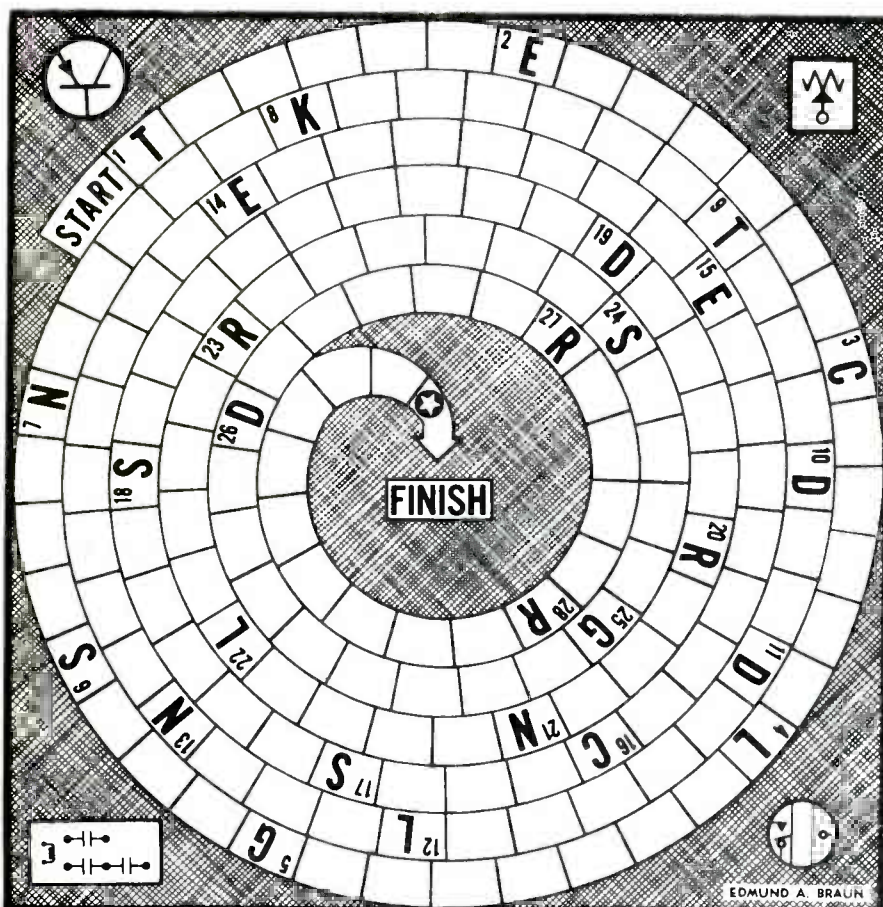

- 1 A 4-electrode vacuum tube.
- 2 Pertaining to a "shocking" type of power.
- 3 In electronics, a potentiometer or variable resistor.

- 4 Transferring energy from a coaxial cable into a wave guide.
- 5 Electromagnet unit of magnetic flux density.
- 6 Unit of sound absorption.

- 7 A chain of stations.
- 8 One thousand units of electric power.
- 9 Group of three dots on screen of color picture tube.
- 10 Pertaining to current-carrying parts not alive or charged.
- 11 A fraction with a power of ten for its denominator.
- 12 System used by ships and aircraft to fix their positions.
- 13 Amplifier circuit used in early tuned-radio-frequency receivers.
- 14 The power per unit area radiated by a source of energy.
- 15 Pertaining to an elliptical rotation or orbit.
- 16 Flexible insulated conductors equipped with terminals.
- 17 Group of assemblies of component parts linked together.
- 18 Device for making various electrical connections.
- 19 Oscillation introduced for the purpose of overcoming the effects of friction, hysteresis, or clogging.
- 20 Heavy, gaseous element.
- 21 Hard, silver-white metallic element much used in various alloys.
- 22 Pertaining to two parallel wires on which standing waves are set up, usually for the measurement of wavelength.
- 23 Restores; returns; substitutes.
- 24 Resilient, flat pieces of metal forming or supporting a compact member in a jack or key.
- 25 Pertaining to a sheet of iron plated with zinc.
- 26 Device for translating a series of secret signals or communications.
- 27 To fix; to restore to good condition.
- 28 A complete rotation.

Now that you're through scratching your head, turn to the solution on page 56.

Reports from the test lab

Each report about an item of electronic test equipment is based on examination and operation of the device in the ELECTRONIC SERVICING laboratory. Personal observations about the performance, and details of new and useful features are spotlighted, along with tips about using the equipment for best results.

By Carl Babcoke

Digital Color-Pattern Generators

Two models of color-bar generators from Simpson are described this month.

Model 431

Simpson Model 431 (Figure 1) is a small, hand-held-size generator that produces color bars, dots patterns, and line patterns. Power is

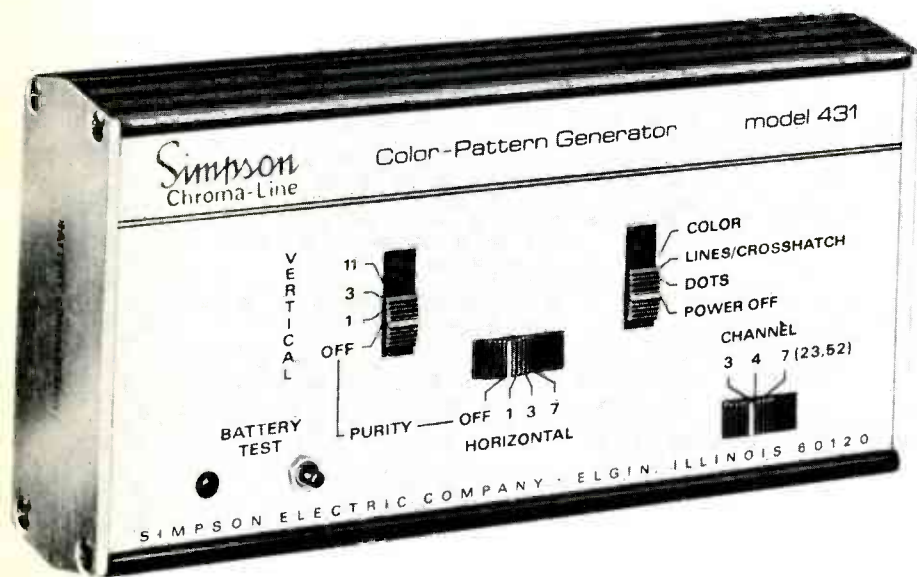

Fig. 1 All functions and patterns of the Simpson Chroma-Line Color-Pattern Generator Model 431 are selected by four sliding switches. The output jack and two level controls are on the right-side panel.

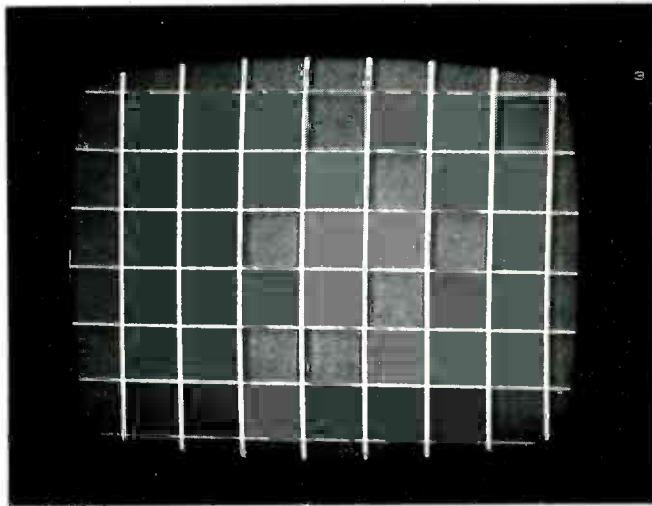
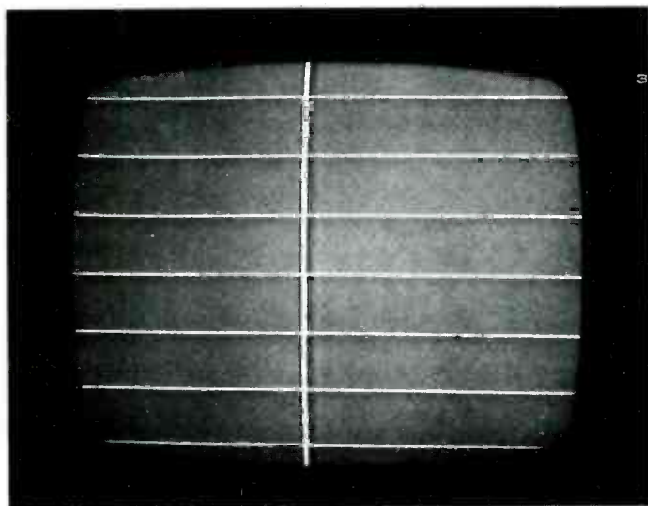

Fig. 2 Separate switches allow a selection of none, 1, 3, or 11 vertical lines or rows of dots; and none, 1, 3, or 7 horizontal lines or rows of dots. Both switches at "off" give a blank raster. These are two of the 18 possible patterns from Model 431.

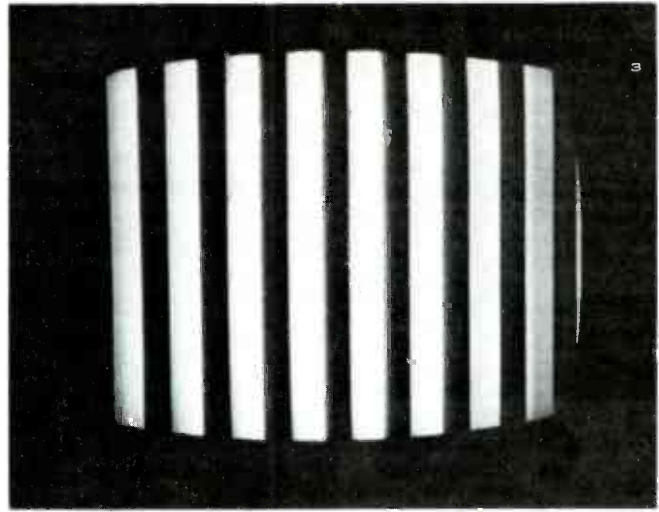
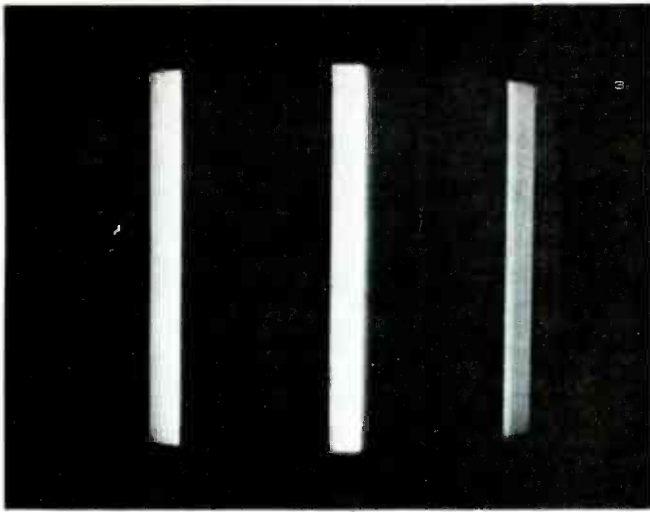

Fig. 3 The three color patterns from Model 431 are the rainbow, three bars, and ten conventional color bars.

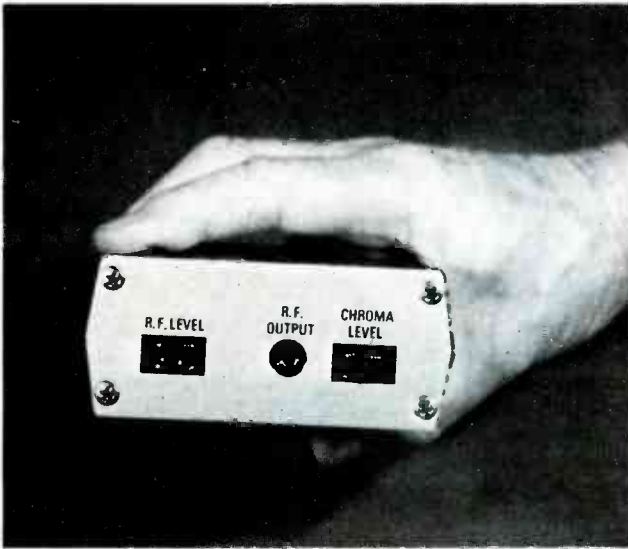

Fig. 4 Side panel of the Model 431 has the RF and chroma level controls, and the output jack for the RF channel carrier. The 9-volt battery is behind the other side panel.

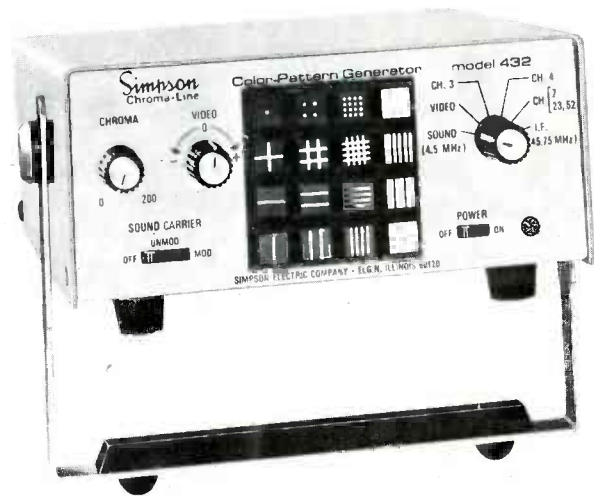

Fig. 5 The Simpson Model 432 Chroma-Line Color-Pattern Generator will supply all signals for color locking and convergence of color receivers. But in addition, it offers sound, IF, and video signals for other tests.

from a single 9-volt internal battery, with a switch and LED on the panel to show the battery condition.

Circuit

Both Medium and Small-Scale Integration (MSI and SSI) in the digital circuitry provide patterns of excellent stability. The 3.563795-MHz color carrier is crystal-controlled. Although the master clock that supplies all gating and lines of the patterns is controlled by a 378-KHz Ceramic Resonator, the accuracy approaches that of crystal-

control. From the 378-KHz, a divide-by-24 counter, and a divide-by-3 counter supply the vertical lines, and a divide-by-262 counter provides the horizontal lines. The channel oscillator is LC-tuned.

Patterns

Three sliding switches select a total of 28 different patterns. One switch selects zero, 1, 3, or 11 vertical lines, or vertical rows of dots. Another gives zero, 1, 3, or 7 horizontal lines, or horizontal rows of dots. Either switch, or both to-

gether, can be used. Or, when both are set to zero, the result is a blank raster, which is useful for checking purity. Figure 2 shows two of the many possible patterns.

A third sliding switch determines the functions, such as color, lines or crosshatch, or power/off. Only the "vertical" sliding switch works with the "color" function. The "11" position gives 10 standard keyed-rainbow bars without black spaces between the bars, while the "3" position (see Figure 3) shows only three color bars corresponding to

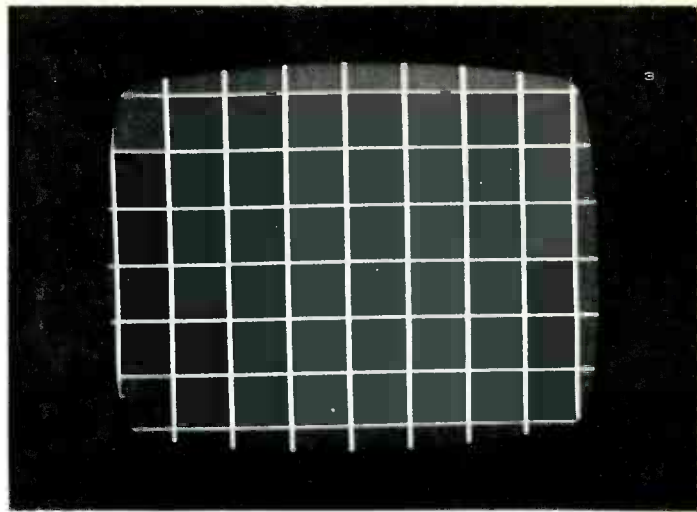
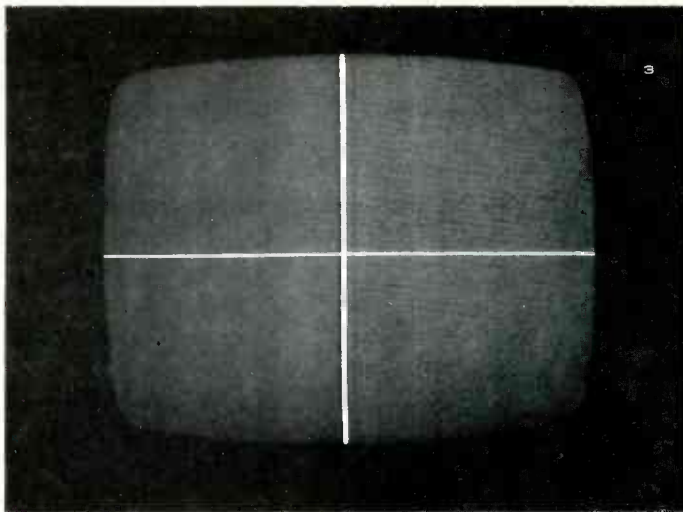

Fig. 6 These four patterns are samples of the 13 lines, dots, or blank raster signals provided by the "touch-command" buttons of Model 432.

Fig. 7 Rainbow, three color bars, and ten conventional color bars are available from Simpson Model 432. The spaces between bars are darker than raster background. Sharpness was good.

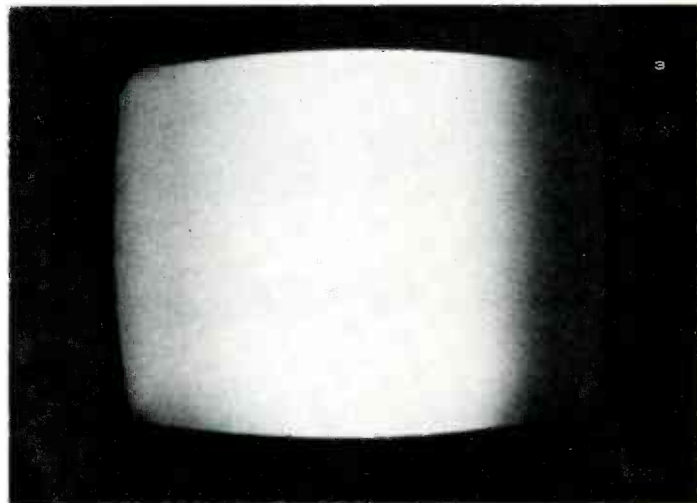
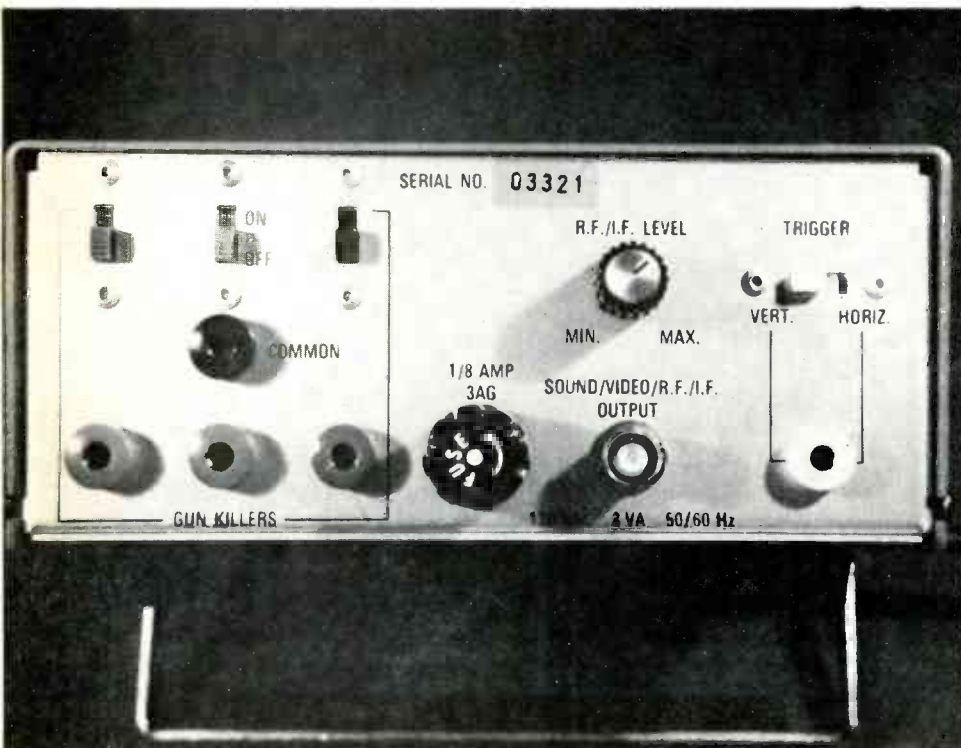

Fig. 8 On the rear panel of Model 432 are the jacks and gun-killer switches, fuse post, sound/video/RF/IF output jack, RF/IF level control, and the switch and jack for vertical and horizontal sync "trigger" signals.



R-Y, B-Y, and G-Y. "O" position provides a color rainbow without bars.

Channels

A fourth sliding switch selects the channel to which you tune the receiver to see the patterns. The fundamental mode is used for Channels 3, 4, and 7, while harmonics of the Channel 7 carrier provide weaker outputs on UHF Channels 23 and 52.

Power

A single 9-volt Alkaline battery is located inside the left side panel, which is held in place by four screws.

To test the battery, turn on the power by selecting a function, then press the "battery test" switch button. If the red LED lights, the battery is okay. This is not just a simple circuit with an LED in series

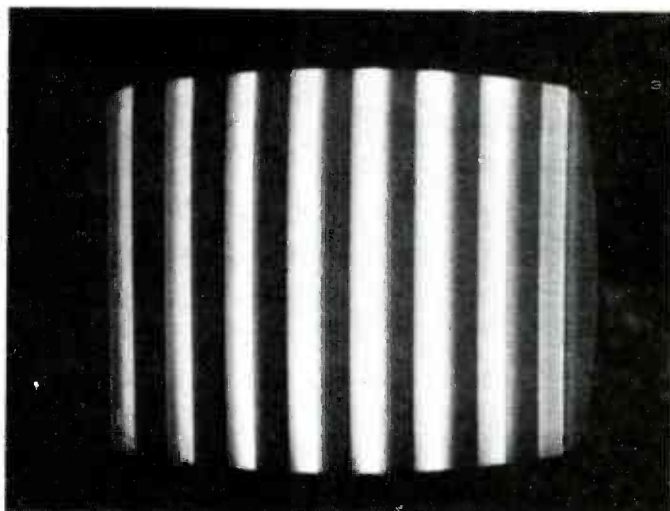
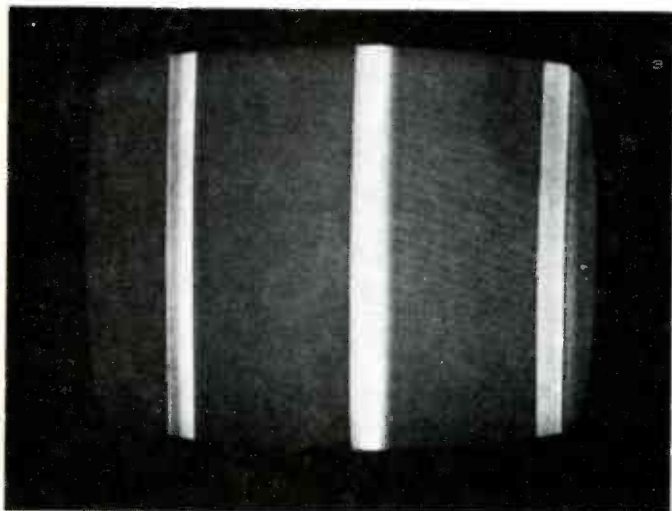
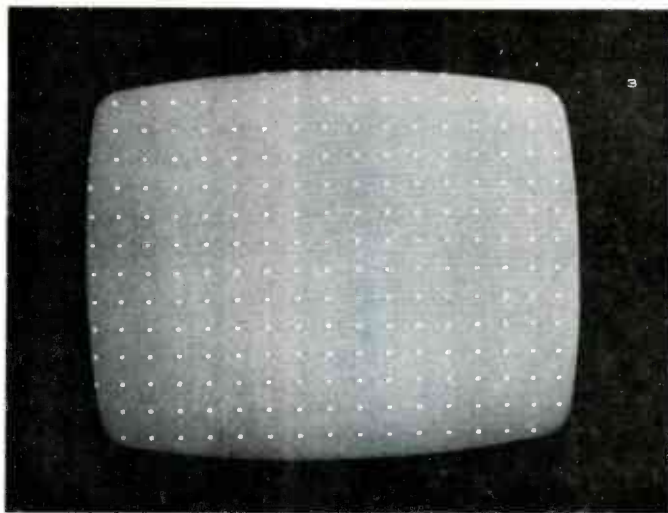
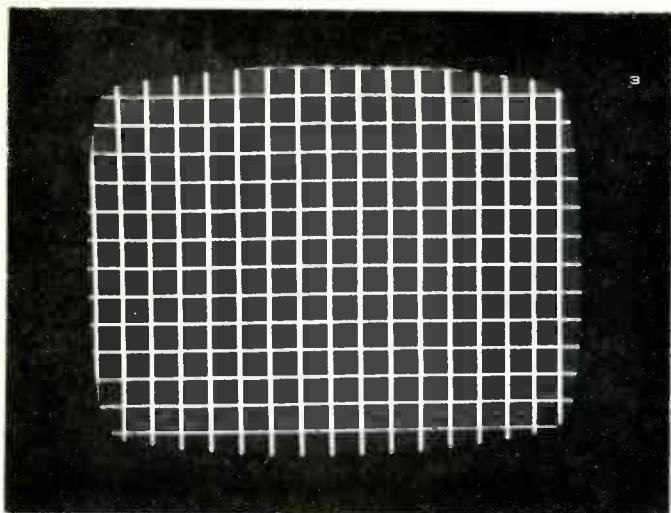

with a resistor. Instead the LED brightness difference between normal voltage and weak voltage is improved by a zener diode and a transistor.

Controls

On the right side panel are the "RF level" and "chroma level" variable controls, and a miniature jack for the RF output signal. (Figure 4).

Price

Simpson Model 431 Color-Pattern Generator sells to technicians for \$89. The operator's manual gives simplified receiver adjustments.

Model 432

Model 432 Simpson Color-Pattern Generator (Figure 5) is a larger, 120-volt AC-operated generator with more features and functions.

Let's start with the front panel controls. At the left is the "chroma"

level control, providing up to 200% color saturation. Below it is that rare feature in generators: a 4.5-MHz sound carrier, with a switch for "off", "unmodulated", or "modulated" with an audio tone. This is a valuable help when setting the fine tuning of receivers that do not have AFT.

To the right of the chroma control is the "video" level. It has zero amplitude at the center of rotation, with negative-going video to the left, and positive-going to the right.

In the center are the 16 "touch command" buttons, which are similar in action to those on calculators. Press a button to select the pattern you want, and the pattern remains after you withdraw your finger, even though the buttons are not the latching type. However, there is one peculiarity: the selected pattern

remains until the generator is turned off. But when turned on the next time, the generator has an unkeyed rainbow, which remains until you push a button for another pattern.

The buttons are marked with the approximate pattern. For example, push the one showing four dots, and the screen will have a 7-by-11 pattern of dots. All 77 might not be visible according to the overscan of the receiver. The button below showing two vertical and two horizontal lines has 7 horizontal lines and 11 vertical ones.

Similarly, the button marked with 16 dots actually shows a 15-by-21 dot pattern. Of course, many receivers are overscanned until many of the edge dots will be lost. Some of the actual patterns photographed from a TV screen are shown in Figure 6.

B&K-PRECISION

**CRT
RESTORER/
ANALYZER**

MODEL 470
\$179



**Pays
for itself
in weeks!**

Has all the important features of more expensive restorer/analyzers.

- Power emission restoration system, restores better than 95% of tubes.
- Automatic timing prevents tube burn-out.
- Tests and restores each gun separately.
- Restores color and black and white tubes.
- Same basic test procedures used for all CRT's including "in-line" and "single-gun" types.

and measures only usable dynamic beam current.

- Removes shorts and leakage.
- Condition of tube displayed on large, multi-color scale meter for easy customer viewing.
- Supplied with 6 most popular tube adapters.
- Continuous update on adapters and CRT data ensures against tester obsolescence.
- In stock at your distributor.

B&K PRECISION
PRODUCTS OF DYNASCAN
6460 W. Cortland Avenue
Chicago, IL 60635 312/889-9087

(Continued from page 53)

The WD-750A VoltOhmyst has an exceptionally bright 3 1/2-digit 3/4" LED display that makes it easy to read even in brightly lit areas. It has a built-in analog meter, a low-power resistance range for measuring resistance in circuits with semiconductors, built-in overrange protection, and automatic zeroing.

The multimeter has six DC and six AC voltage ranges covering from 1 mV to 1,200V. There are five current ranges from 1 microampere to 1 ampere and six resistance ranges from 1 ohm to 10 megohm. Resolution is about 0.1% full scale, and the input impedance is 10 megohms for all voltage ranges. The analog meter can be very handy when you are peaking

or nulling, and do not require accuracy.



The unit is powered by either 120V AC or by its own built-in rechargeable nickel-cadmium battery. Suggested price is \$267.

For More Details Circle (37) on Reply Card

RF Wattmeter

Motorola Communications and Electronics now has available a new RF wattmeter, plus a complete line of "N" type and UHF connector elements.

The compact wattmeter is designed for plug-in, in-line elements. The bi-directional element is clipped into the meter to read both forward and reverse power. Separating the meter from the element automatically damps the meter movement for protection

against mechanical shock during transit. Motorola's rugged elements are designed to resist damage from dust, dirt, moisture and droppage. The RF cavity and sense line are an integral part of the element. Another benefit of the elements is that they may be left connected in antenna or transmission lines, thus eliminating the need to go off the air when measuring power.

For More Details Circle (38) on Reply Card

TRANS-VISTA ELECTRONICS

Distributors Of Transistors And Famous Trans-Vista Electron Tubes

80% To 90% OFF
LIST PRICES OF TUBES BELOW

| Type | List Price | Your Cost | Type | List Price | Your Cost |
|-------|------------|-----------|-------|------------|-----------|
| 1G3 | 5.25 | .78 | 6GH8A | 4.20 | .73 |
| 3A3 | 5.35 | .91 | 6HA5 | 5.10 | .88 |
| 3AT2 | 5.20 | .83 | 6HZ6 | 4.25 | .71 |
| 3DB3 | 5.85 | .93 | 6JE6 | 11.15 | 1.67 |
| 3GK5 | 5.15 | .87 | 6JS6 | 9.90 | 1.38 |
| 5GS7 | 3.70 | .67 | 6KD6 | 11.25 | 1.49 |
| 6AD10 | 12.25 | 1.59 | 6LF6 | 10.65 | 1.62 |
| 6AW8A | 5.95 | .84 | 6LX8 | 3.50 | .52 |
| 6BA11 | 6.50 | .85 | 6PQ7 | 4.05 | .69 |
| 6BK4 | 9.95 | 1.41 | 12BY7 | 4.75 | .61 |
| 6BZ6 | 6.95 | .70 | 17AY3 | 5.05 | .75 |
| 6CG3 | 5.25 | .81 | 17JZ8 | 4.75 | .71 |
| 6CJ3 | 5.00 | .79 | 19CG3 | 6.65 | .99 |
| 6EJ7 | 4.75 | .76 | 22KM6 | 10.25 | 1.39 |
| 6FQ7 | 4.05 | .69 | 33GY7 | 8.05 | 1.20 |
| 6GF7A | 7.05 | .99 | 38HE7 | 9.75 | .99 |

Trans-Vista sells all types of tubes at 80% off list prices. To figure your cost multiply current list price by 20. Order today!

TRANSISTOR SPECIALS

| Our No. | Similar To | List Price | Your Cost | Our No. | Similar To | List Price | Your Cost |
|---------|------------|------------|-----------|---------|------------|------------|-----------|
| TVE5 | ECG123A | 2.20 | .79 | TVE8 | SK3019 | 2.55 | .84 |
| TVE7 | ECG128 | 3.30 | .91 | TVE9 | ECG152 | 4.20 | 1.09 |
| TVE3 | SK3004 | 1.90 | .72 | TVE12 | ECG165 | 19.50 | 4.87 |

1 million transistors in stock. Order any type not listed at 75% off list prices.

Terms: All shipping charges paid on pre-paid orders. Send full remittance, un-used money returned. COD orders 25% deposit.

PHONE ORDERS CALL (201) 688-1466

All tubes individually boxed, branded, lab tested new, 2nds, or used. 1 year warranty. Money back if not satisfied. Use this ad as order form. Send for free tube and transistor lists.

TRANS-VISTA

795 Colonial Arms Road
Union, N.J. 07083 (DEPT. ES-9)

For More Details Circle (17) on Reply Card

CB Power/VSWR Bridge

Antenna, Incorporated has introduced a CB radio power-meter and voltage-standing-wave-ratio (VSWR) bridge, manufactured for them by Bird Electronics.

The meter has Bird Electronics' Thurline design and measures RF output power up to 10 watts, as well as providing VSWR measurements. A major feature of the meter is that it does not require a perfect impedance match to read accurately. It will read



within ±5% regardless of the input-output impedance match.

Suggested price of the Model 10043 is \$88.

For More Details Circle (39) on Reply Card

productreport

These features supplied by the manufacturers are listed at no-charge to them as a service to our readers. If you want factory bulletins, circle the corresponding number on the Reply Card and mail it to us.

Semiconductor Kit

A new replacement-semiconductor kit for CB radio service requirements has been introduced by **Raytheon**.

Packed in a 24-drawer cabinet, the CB replacement kit features 34 different Raytheon "RE" semiconductor types that are direct electrical and mechanical replacements for the 474 part numbers most used in CB equipment. The kit also includes a free copy of the latest edition of Howard W. Sams "1-2-3-4 Servicing of Transistor CB and 2-way Radios," plus a free copy of a complete and up-to-date CB replacement guide.

For a limited time, the kit is available from Raytheon "RE" distributors for \$76.00

For More Details Circle (40) on Reply Card

Anti-Theft Alarm

The Radio-Sentry CB Theft Alarm from **Electronic Specialists** can guard two items such as a CB radio and a tape deck. Tampering or equipment removal activates the electronic, solid-state sensor, sounding the vehicle horn. Options include a siren for extra protection and an expanded sensor which will operate as a vehicle burglar alarm in addition to providing CB protection. The Radio-Sentry is easy to install.

For More Details Circle (41) on Reply Card

Home Security System

A self-contained, plug-in security system for the home now is available from **Mountain West Alarm Supply Company**.

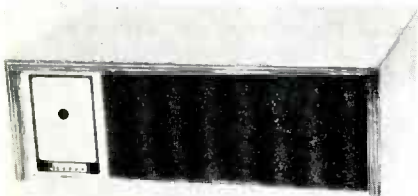

The heart of the S22 microwave intruder-detector system is a field-disturbance sensor. The sensor projects a teardrop shaped radiation pattern a maximum of 75 feet by 45 feet. An intruder walking within the protected area causes a doppler frequency shift which is electronically converted to an alarm signal. A range control allows adjustment of the size of the protection area.

Other features of the S22 include: timing circuits to permit exit and entry; automatic alarm reset; fast-sweep siren for connection to standard loud speakers; inputs for easy hook-up to external sensors such as door and window contacts and fire sensors; and a rechargeable standby battery. The S22 lists for \$259.

For More Details Circle (42) on Reply Card

CB Preamp

A new preamplifier for CB transceivers has been developed by **Chemtronics, Inc.**



Called the CB Xtender, the unit provides a 20-dB amplification of incoming CB radio signals, thus bringing in more distant signals and extending the receiving range. The Xtender amplifies 2 MHz to 30 MHz,

(Continued on page 56)

FREE FREE

to introduce you to the many advantages of

SOLID STATE REPLACEMENT RECTIFIER TUBES

Solid state rectifier tube replacements offer many servicing and profit advantages: • 6 Solid-Tube® types replace up to 37 different high voltage vacuum tubes. • They're something your customers will appreciate. • Eliminates need to replace defective filament winding on flyback. • No X-radiation. • Reduces fire hazards. • No filaments to fail. Reliable. Solid state. • Faster warm-up for picture. • Modernizes older sets. • Much higher profit than vacuum tubes.

Get the full story on EDI Solid-Tubes® rectifiers, and get a free Silicon Focus Rectifier too, just by asking - on your letterhead or business card, please.

edi ELECTRONIC DEVICES, INC.
21 Gray Oaks Ave.,
Yonkers, N.Y. 10710
Telephone 914-965-4400

For More Details Circle (19) on Reply Card

SHIRT-POCKET PROFIT!



ONLY \$85.00

Factory assembled & calibrated

The **Heath SG-5240** color alignment generator. A truly portable generator that takes your prime Color TV service tool out of your shop and on to the job in your shirt pocket.

Crystal controlled carrier oscillator and sixteen test and alignment patterns will give you all the stability and display versatility you are ever likely to need.

Portability, stability and versatility from the world's largest manufacturer of superior-quality, low-cost electronic kits.

Heath/Schlumberger SG-5240 factory tested and calibrated

..... only \$85.00

ORDER TODAY!

Heath Company, Dept. 25-214
Benton Harbor, Michigan 49022

| | |
|--|--|
| HEATH Schlumberger | Heath Company, Dept. 25-214 Benton Harbor, Michigan 49022 |
| I want to put profits in my shirt pocket. | |
| Send me | |
| <input type="checkbox"/> Heath/Schlumberger SG-5240 color alignment generator. Factory assembled, tested and calibrated. \$85.00 (+ .95 shipping and handling) | |
| My <input type="checkbox"/> check <input type="checkbox"/> money order for \$ _____ enclosed. Michigan residents add 4% sales tax. | |
| Name _____ | |
| Address _____ | |
| City _____ | |
| State _____ Zip _____ | |
| TE-338 | |

For More Details Circle (18) on Reply Card

ACA

Chroma POWER

TV and FM ANTENNAS
AND ELECTRONICS

ANTENNAS
FIELD-ENGINEERED
and TESTED
in your area
FOR YOUR AREA

CALL or WRITE:

ACA, P. O. Box 865,
Burlington, IA 52601
Phone: 319-753-1625

For More Details Circle (20) on Reply Card.

NOW-IT'S HERE!
BY POPULAR DEMAND
Full Four-Digit DMM

With Rechargeable
Batteries & Charger Unit

\$190



Another
Volksmeter— **LM-40**

Features Include:

- Super Rugged - Ideal for field service use.
- Accuracy - 0.1%. 19 ranges: 4 vdc, 4 vac, 5 ohms and 6 current (optional).
- Automatic zeroing and polarity.
- Full four digits enhances low ohms measurement.
- Small size: 1.9" H x 2.7" W x 3.9" D.
- Fully protected input.

Also a 1%, 3-digit LM-3 @ \$125, a 1%, 3-1/2-digit LM-3.5 @ \$147 and a 0.05%, 4-digit LM-4 @ \$227.

See your local distributor!

Distributor inquiries invited.



Non-Linear Systems, Inc.

Originator of the digital voltmeter.
Box N, Del Mar, California 92014
Telephone (714) 755-1134 TWX 910-322-1132

For More Details Circle (21) on Reply Card

(Continued from page 55)

with a noise figure of less than 2 dB. It may be used with both AM and SSB transceivers, and will accommodate the new CB frequencies in the HF band. A time-delay circuit prevents the preamplifier from cutting in and out during single sideband trans-

missions.

Easy to install, the CB Xtender operates from 10 to 15 VDC; an LED indicator is provided to remind the CBer when power is on. Suggested list price is \$39.95.

For More Details Circle (43) on Reply Card

Soldering Station

Ungar has available a cordless Quick Charge soldering station.

The #200 soldering station consists of a rechargeable iron with a quick-charge nickel-cadmium battery; it is designed to accept two rigid interchangeable tips, and the charging holder completely recharges the battery in 4 hours.

Other features include an easy-touch operating trigger control with interlock "off" switch, a built-in lamp, and a built-in sponge tray.



For More Details Circle (44) on Reply Card

CB Accessory Spray

Tech Spray has a new product for the CB market which will be distributed under the brand name of Klear Tone. The product, called CB Whip-It, is an effective aid to prevent corrosion and oxidation of antennas. It also prevents seizing of base antenna telescopic joints and pro-

TECTS contacts in quick-disconnect mounts and all rotating or sliding parts. Other features include lubricating and protecting contacts of switches in auto intrusion alarms and all rubber parts and cables. It is safe for plastics and is non-flammable.

For More Details Circle (45) on Reply Card

Interference Filters

RMS Electronics has introduced two new interference filters for MATV and home-TV systems.

For 75-ohm TV systems, RMS has the Model 2600F combination CB interference filter and 75-to-300 ohm matching transformer. The filter minimizes interferences from CB, ham radio, two-way communications, X-ray, diathermy, etc. Two features of the Model 2600F filter are a miniaturized printed circuitry and a totally shielded network and housing.

Model CB-200F is a CB interference filter for 300-ohm systems that connects directly to the VHF antenna terminals on the rear of the TV set. It can be used in conjunction with RMS Model MA-332 or SPF-555 splitters for VHF and UHF reception.

For More Details Circle (46) on Reply Card

Advertising Hub Cap

Goodrich Products has developed a new method of advertising by printing a message on a non-revolving automobile hub cap that is designed to be aero-dynamically stable and does not rotate when the car is in motion, thus calling attention to the message. Suggested price of the hub cap is \$24.95.

For More Details Circle (47) on Reply Card

Solution to: LOTS A SHORT CIRCUITS

- | | |
|---------------|----------------|
| 1 TetroDE | 15 Eccentric |
| 2 ElectriC | 16 CordS |
| 3 Control | 17 SystemS |
| 4 LaunchinG | 18 Switchboard |
| 5 Gauss | 19 Dither |
| 6 SabiN | 20 Radon |
| 7 Network | 21 Nickel |
| 8 Kilowatt | 22 Lecher |
| 9 Triad | 23 ReplaceS |
| 10 Dead | 24 Spring |
| 11 DecimaL | 25 GalvanizeD |
| 12 LoraN | 26 DecodeR |
| 13 NeutrodyNE | 27 Repair |
| 14 EmittancE | 28 Revolution |

Start with 112 points and deduct 4 points for any part you may not have answered correctly.

Your rating:

68 - 72 Norm.

76 - 84 Super.

88 - 96 Ultra.

100 - 108 Ultra-ultra.

112 PERFECT!

You've earned our First Annual
Imaginary Trophy.

ELECTRONIC SERVICING

bookreview

Servicing Biomedical Equipment

Author: Elliott S. Kanter

Publisher: Howard W. Sams & Co., Inc., 4300 West 62nd Street, Indianapolis, Indiana 46268

Size: 160 pages, book number 21011

Price: \$5.50 paperback (In Canada \$6.60)

Doctors and nurses spend many years learning the medical and physiological facts necessary to good patient care. Unfortunately, most of them never receive adequate training in the use and care of medical equipment. This is where the biomedical technician comes in. Elliott Kanter acquaints the prospective biomedical technician with the types of electronic and electro-mechanical devices found in modern-day hospitals. He has collected day-to-day observations on how medical devices fail, put together technical data on how to fix them, and made suggestions on how some of the damage can be avoided in the first place.

Contents: Getting Into The Field; Employment Opportunities; Type And Volume of Service; The Hospital, A Different Sort of Customer; Getting Started; Electrical Safety; Electrical Safety: Test Procedures and Techniques; Centrifuges; Electrocardiographs; Defibrillators; Monitoring Devices; Oxygen and Vacuum Devices; Other Equipment; Appendix; Bibliography; Index.

Impedance

Author: Rufus P. Turner

Publisher: Tab Books, Blue Ridge Summit, Pennsylvania 17214

Size: 196 pages, book number 829

Price: \$8.95 hardbound, \$5.95 paperback

This reference book tells what impedance is, how to work with it and use it in electronics calculations, and how to turn it into a tool when faced with specific design problems involving the transfer of energy from one circuit or stage to another. Beginning with AC theory and working through impedance theory and inductance, Turner includes shortcut methods for measurement and computation; plus complete information on how to wind your own chokes and coils for any application. The material is presented in an easy-reference format, with every section, equation, and example number-coded. Examples and illustrations are provided for each major topic discussed, and sample problems are presented at the end of each section.

Contents: AC Fundamentals; Nature of Impedance; Impedance Measurements; Inductance; Practice Exercises; Appendixes; Impedance Conversion Factors; Phase Angle Data; Abbreviations; Answers; Index.

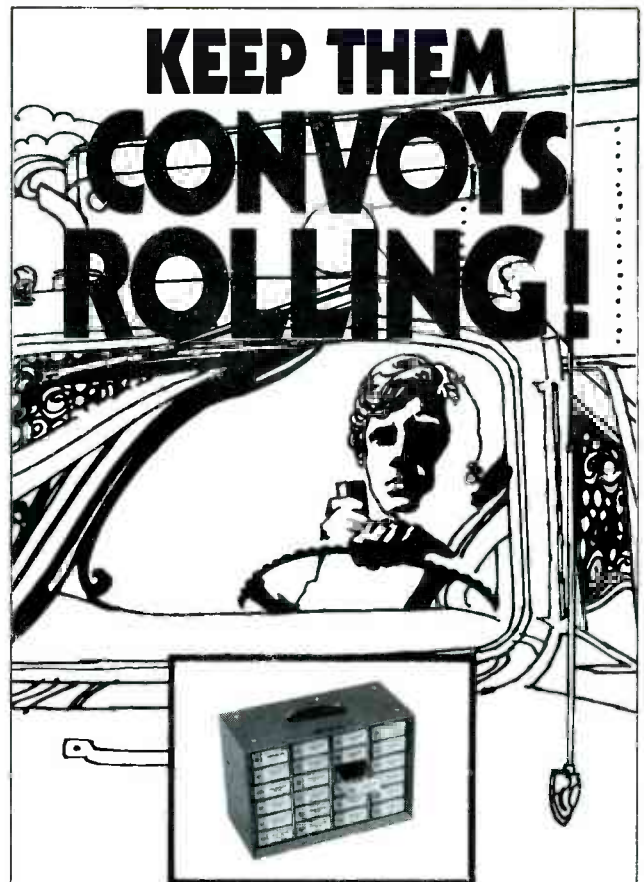

GE replacement semiconductor kits to fit most popular CB rigs.

GE kits—a great way to gear up for CB rig and scanner repair business. Parts you need most now! Really fast-growing segment of electronics. Over 7,000,000 CB rigs reported in use, with sales skyrocketing. Are you ready to fix 'em? See your authorized GE distributor for kits complete with special CB cross-reference guide (your key to picking the right replacement semiconductor for each popular brand rig).

Tube Products Department
General Electric Company
Owensboro, Kentucky 42301

GENERAL  **ELECTRIC**

REMEMBER!

The GE Tube Flap Award Program means

VALUABLE GIFTS.

Deadline is November 30, 1976.

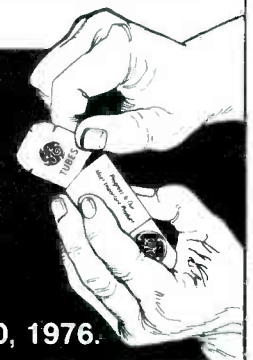

ARROW AUTOMATIC STAPLE GUNS

CUT WIRE & CABLE INSTALLATION COSTS

... without cutting into insulation!

SAFE! Grooved Guide positions wire for proper staple development! Grooved Driving Blade stops staple at right depth of penetration to prevent cutting into wire or cable insulation!

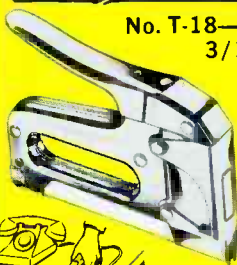

No. T-18—Fits wires up to 3/16" in diameter.

BELL, TELEPHONE, THERMOSTAT, INTERCOM, BURGLAR ALARM and other low voltage wiring.

Uses T-18 staples with 3/16" round crown in 3/8" and 7/16" leg lengths.

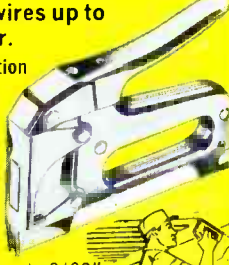

No. T-25—Fits wires up to 1/4" in diameter.

Same basic construction and fastens same wires as No. T-18.

Also used for RADIANT HEAT WIRE

Uses T-25 staples with 1/4" round crown in 9/32", 3/8", 7/16" and 9/16" leg lengths.



NEW! Intermediate No. T-37—Fits wires and cables up to 5/16" in diameter.

Same basic construction as Nos. T-18 & T-25.

Also used for CATV and DRIVE RINGS in stringing wires.

Uses T-37 staples with 5/16" round crown in 3/8", 1/2" and 9/16" leg lengths.



No. T-75—Fits wires and cables up to 1/2" in diameter.

RADIANT HEAT CABLE, UF CABLE, WIRE CONDUIT COPPER TUBING or any non-metallic sheathed cable.

Also used as DRIVE RINGS in stringing wires.

Uses T-75 staples with 1/2" flat crown in 9/16", 5/8" and 7/8" leg lengths.

ARROW FASTENER COMPANY INC.
271 Mayhill Street, Saddle Brook, N. J. 07663

catalogs literature

Circle appropriate number on Reader Service Card.

80. Heath Company—has a free catalog that includes complete descriptions of over 400 electronic kits—from build-it-yourself color TV and hi-fi equipment to amateur radio gear. Two new products introduced are an electronic digital miles-per-gallon monitor/speedometer, and a low-cost fire and smoke detector kit.

81. Dana Laboratories—a 16-page, four-color brochure describes Dana's full line of 3-1/2 and 4-1/2 digit multimeters. A complete product line recap provides a summary of Dana's other DVM's as well as frequency counters. Included is a detailed accessory listing, as well as a color-coded specification chart covering the 3-1/2 and 4-1/2 digit multimeters. Highlighted is Dana's new 4600 digital multimeter.

82. Breaker Corporation—offers a 12-page, full-color catalog with a Bicentennial theme. The "Freedom" line of 27-MHz mobile, trucker, and base-station CB antennas and accessories is described with many application pictures. A technical reference section provides useful tips on antennas and CB rig operation.

83. Tab Books—free 44-page 1976 catalog describes over 400 current and forthcoming books, plus 14 of the firm's electronic book/kits. Some of the subject matter listed includes: Amateur Radio License Study Guides; Appliance Repair; Basic Electronics Technology; Communications—2-Way, Shortwave and CB Radio; Do-It-Yourself; FCC License Study Guides; Radio Receiver Servicing; Television Servicing; and many other subjects.

84. Mouser Electronics—offers a free 56-page electronics purchasing manual. Electronic components, test equipment, tools and production aids are some of the items featured.

85. Pomona Electronics—announces its 25th anniversary catalog of electronic test accessories. The 76-page publication includes a special new-products section, hundreds of photographs, and separate sections on molded banana plugs, banana plug accessories, molded patch cords, cable assemblies, test socket adaptors, spaced molded accessories, molded test leads, connecting leads, and IC test clips. Special charts cover a cross index of UG numbers, and an alphabetical and numerical index is included.

86. Enterprise Development Corporation—features the full line of Endeco soldering and desoldering equipment in their "Catalog 76". Included are soldering irons, desoldering irons, kits and the desoldering head that converts a soldering iron into a desoldering iron. Also shown are tips, desoldering bulbs, solder paks and soldering tool stands.

87. Cornell-Dubilier—has released their 1976 General Line Catalog and Electrolytic Guide for professional electronic technicians and engineers. The 86-page catalog provides cross references, specifications and configurations. Included are twist prong, electrolytic (aluminum) film dielectric, AC, mica dielectric, ceramic dielectric and DC Kraft. Information on CDE's relays, TV/FM antenna rotor systems and CB noise filters are also provided.

88. Fordham Radio—offers a complete line of electronic equipment and accessories in their 1976 catalog. They specialize in selling test equipment, featuring such names as B&K, Hickok, RCA, Leader, Sen-core, Simpson and many others. Considerable savings are offered on receiving tubes, parts, and CB equipment. Also included are parts kits, tools, and soldering equipment. □

FREE ALARM CATALOG

Huge selection of burglar & fire systems, supplies. Motion detectors, infrared beams, controls, door switches, bells, sirens, 300 items, 64 pp. packed with technical details, notes.
Phone (602) 263-8831



mountain west alarm
4215 n. 16th st., phoenix, az. 85016

| | |
|---|----------|
| CORONADO TV6-2045B | 1600-1 |
| HITACHI P-A1, P-C2, P-08, P-55 | 1601-1 |
| JC PENNEY 685-1721 A, 855-2325, 1721 A | 1599-1 |
| K MART SKC1980 | 1603-1 |
| MAGNAVOX Chassis T991-01-AA thru T991-05-AA | 1594-1 |
| Remote Control Receiver 703683-7, Transmitter 704090-0 | 1594-1-A |
| QUASAR Chassis 12TS-957 | 1600-2 |
| RCA Chassis KCS201C/D/H | 1602-1 |
| SEARS 528.44040500/501 | 1593-1 |



**D-612T
DC
POWER
SUPPLY**

LOWEST PRICE/WATT + these other exclusives:

- 1) Variable dc output. 2) Full 10-amp rating over 0-12 v range. 3) Super filtering over entire output. 4) Dual range. 5) Heavy overload capacity. 6) Fully enclosed steel cabinet. 7) Large, easy-to-read meters. 8) Full year warranty.

21 Stock Models from 6 to 125 vdc. See Your Distributor. Custom OEM Power Supplies Engineered to Your Requirements.

Send for FREE BULLETINS • See EEM for Data on Full Line

EPSCO, Inc., 922 Westwood, Addison, IL 60101 • 312/543-0410



5155

The Same Reliable Line Founded by ELECTRO in 1936

For More Details Circle (29) on Reply Card

Make working on CB's easier with the CommLine from Hickok.

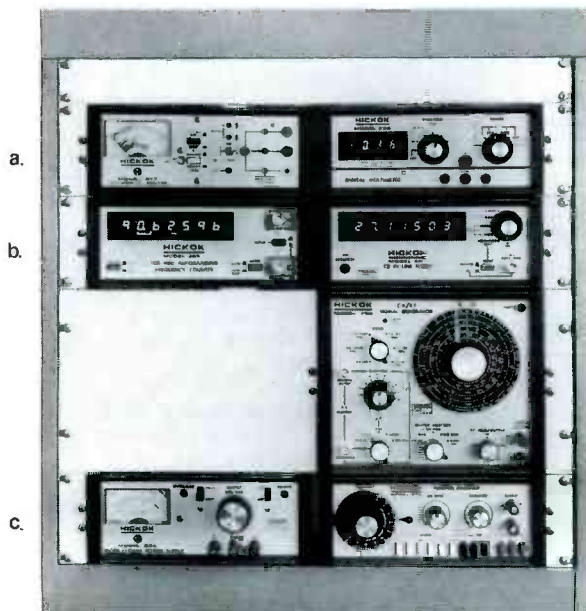

- a) Model 217 Semiconductor Analyzer. \$169
- b) Model 385 Autoranging 500 MHz Frequency Counter. \$499
- c) Model 244 Mobil/Comm Power Supply. \$125
- d) Model 334 Digital Multimeter. \$234
- e) Model 388X Pro CB In-Line Tester. \$475
- f) Model 256 CB / RF Signal Generator. \$199
- g) Model 270 Function Generator. \$189
- h) Model CL-1 CommLine Rack Cabinet. \$35

HICKOK To put together exactly the CommLine
CommLine CB Service Center you need,
see your Hickok distributor.

HICKOK
the value innovator

INSTRUMENTATION & CONTROLS DIVISION
THE HICKOK ELECTRICAL INSTRUMENT CO.
10514 Dupont Avenue • Cleveland, Ohio 44108
(216) 541-8060 • TWX: 810-421-8286

For More Details Circle (30) on Reply Card

The MARKETPLACE

Advertising rates in the Classified Section are 35 cents per word, each insertion, and must be accompanied by cash to insure publication.

Each initial or abbreviation counts a full word.

Minimum classified charge \$3.00.

For ads on which replies are sent to us for forwarding (blind ads), there is an additional charge of \$3.00 per insertion to cover department number, processing of replies, and mailing costs.

Classified columns are not open to advertising of any products regularly produced by manufacturers unless used and no longer owned by the manufacturer or a distributor.

HELP WANTED

EXPERIENCED TV AND/OR 2-WAY SERVICE MAN with an established, expanding, electronics company. Insurance, paid vacation & holiday - chances for advancement. Salary depends on experience. Miller's Radio Shack, Inc., 801 Texas, Goodland, Kansas, 913-899-2386. 9-76-11

FOR SALE

NEW Canadian Magazine "Electronics Workshop" \$5.00 yearly. Sample \$1.00. Ethko, Box 741, Montreal "A" Canada. 10-75-12t

OLDER & OBSOLETE—Radio & TV tubes. All new and boxed. Old Sam's Photofacts too. If it is an oldie we have it. Send \$1.00 (Refundable) for tube catalog. Garrenti's, P.O. Box 2055, San Diego, Calif. 92112. 8-26-2t

TV & RADIO TUBES 36c EA!! Free color catalog. Cornell, 4221 University, San Diego, California 92105. 8-76-tf

STOP...don't junk that television set. ASE manufactures the world's most complete line of television picture tubes. No other company offers: Over 2200 types of television picture tubes. Most types immediate delivery. Transportation paid in some areas. Tubes for old or new models. Complete line of black & white and color. Full 2 year factory warranty. Lowest prices anywhere. Finest quality. We accept BankAmericard and Master Charge. Write today for more information. Allied Sales & Engineering, Inc., Dept. 40, Pimento, IN. 47866. Telephone - 812-495-6555. 8-76-2t

UNUSUAL SURPLUS AND PARTS Catalog. \$1. ETCO Electronics, Dept. E.S., Box 741, Montreal "A" H3C 2V2. 7-76-10t

LATEST EICO OSCILLOSCOPE—4601DC wide band - \$100. J. Steigler, 74 Herbert Ave., Massapequa, New York, 11762. (516) 799-6152. 9-76-1t

PICTURE TUBE MACHINE—We buy and sell NEW and USED CRT rebuilding machinery. COMPLETE TRAINING. Buy with CONFIDENCE from the ORIGINAL MFR. For complete details, send name, address and zip code to: LAKESIDE INDUSTRIES, 3520 W. Fullerton Ave., Chicago, Ill. 60647, Phone: 312-342-3399. 9-76-1t

SELLING SAMS PHOTOFACTS 1-775. Rider's Radio manuals. Also, Supreme manuals, 14 volumes, \$54.50 value, only \$28. Beitman, 1760 Balsam, Highland Park, IL. 60035. 9-76-1t

FOR SALE (CONT.)

TRANSISTOR TESTER. Convert transistor radio into in-circuit transistor tester. Tone indicates good transistor. Plans \$2.00. SZA Electronic Systems Inc., 39 Bayberry La., Levittown, NY 11756. 7-76-3t

RCA 19" PORTABLE TEST JIG—\$90, including adaptor plugs. Heath IG57 alignment generator - \$90 and IG-37 stereo generator - \$50. J. Malmberg, - 1715 Crosby Rd., - Wayzata, Minnesota, 55391. Phone 612-473-4322. 9-76-11

TV TECHNICIANS: Plans for a tripler checker and instructions. Send \$2.95; J & S Electronics, P.O. Box 8335, Shreveport. La. 71108. 9-76-2t

COLOR-BAR GENERATOR 16 patterns, pocket size. CMOS-LSI chip, one transistor. Complete plans \$5. Workshop, Box 393-ES, Bethpage, N.Y. 11714. 9-76-11

MAKE OFFER: Like-new Heathkit equipment: color dot-bar generator, oscilloscope, transistorized VOM, plus capacitor and resistor boxes; also, 10-volume Bell & Howell TV course, Lafayette tube/transistor checker, Electro-Lab design console, and assorted tubes at 25c each. A. Limback, 12527 Sandpiper, Angleton, Texas, 77515. 9-76-11

SOLID STATE & HOBBY CIRCUITS MANUAL

\$1.95 postpaid to your door. The new manual offers over 400 pages of circuits for the hobbyist, engineer, experimenter and do-it-yourself kit builder. HURRY—Supply limited. Free catalog. Frazer & Associates, Dept. ES, 1888 Century Park East Suite 10, Century City, Calif. 90067.

EDUCATION-INSTRUCTION

REPAIR TV TUNERS—High Earnings; Complete Course Details. 12 Repair Tricks, Many Plans, Two Lessons, all for \$2. Refundable. Frank Bocek, Box 3236 Enterprise, Redding, Calif. 96001. 8-76-tf

CONVERT YOUR B&K 465 OR 466 REJUVENATOR to a powerful c.r.t. restorer system. Step by step plans with pictures. \$8.00. James Chancellor, 1708 Edgerly, Albany, Ga. 31707. 8-76-2t

FREE giant bargain electronic catalog listing thousands of components, tubes, transistors, IC's kits, test equipment. EDLIE'S, 2700-EB, Hempstead Tpke., Levittown, N.Y. 11756. 9-76-3t

TV PROBLEMS??? Send symptoms with a copy of schematic and self-addressed stamped envelope and \$2.00. to Box 2041, Downey, Ca. 90242. Results Guaranteed. 9-76-tf

TV SHOPS INCREASE YOUR INCOME BY UP-DATING MATV systems with patented method. Training available. P.O. Box 809, Boynton Beach, Fla. 33435. 9-76-6t

BUSINESS OPPORTUNITY

TV SALES & SERVICE in same location 15 years. Nets over \$25,000. Retiring. Including truck, equipment & inventory \$25,000. A. Bolin, 6361 Balsam Lake, San Diego, Ca. 92119. 6-76-tf

BOOST PROFITS—Don't turn away business. We repair original equipment car radios. Write: Audio Repair, 2113 Admiral Street, Aliquippa, PA 15001. 9-76-2t

TV SALES & SERVICE—Established 15 yrs. 2 houses, shop on corner lot. Servicing over 500 motel sets, mostly color, very good volume, drive-in service, good reputation. Inquire 305-267-9570, Titusville, Florida. Will show figures to interested buyers only. 9-76-1t

BUSINESS OPPORTUNITY

BEAUTIFUL SCENIC MONTANA—Take over 20 year TV Sales and Service business. Gross \$45,000. For more details write: Box 370, Red Lodge, Montana, 59068 or call (406) 446-1102. 8-76-3t

WHERE & HOW TO GET USED TV'S for rebuilding in quantity. Complete information & method, \$10 ppd. EPS, Box 8736, Denver, CO 80201. 9-76-11

EXCEPTIONAL OPPORTUNITY for qualified person to buy well established, AMF mower sales and appliance repair service. Includes residence, van, and inventory. Rogers Realty, 515-753-3433, Marshalltown, Ia. 9-76-2t

FOR SALE TV SALES & SERVICE BUSINESS. Zenith dealership, stocked TV's & parts. In the beautiful Bitterroot Valley, clean air, mild winters, recreation, fishing, hunting, skiing, in Gods country. Priced to sell. Retiring. PH. 406-777-5111, John Mednansky, Stevensville, Mt. 9-76-11

NEED SECOND INCOME? There is money in rejuvenating picture tubes. Color & B/W. Amazing results. Build re-juvinator costing \$200 - \$450 from spare parts around shop. Detailed plans & instruction - \$6.95. Discount Electronics, Box 1535, Pinellas Park, Fla. 33565. 9-76-2t

advertisers' index

| | |
|----------------------------------|---------------------|
| American Technology Corporation | 2 |
| Antenna Corp. of America | 56 |
| Arrow Fastener Co., Inc. | 58 |
| B & K Div., Dynascan Corp. | 54 |
| Bussman Mfg. Div., | |
| McGraw-Edison | Cover 3 |
| Charous & Niebergall | 9 |
| Cost Effective Components | 53 |
| Electronic Devices, Inc. | 55 |
| EPSCO, Inc. | 59 |
| John Fluke Mfg. Co., Inc. | Cover 4 |
| GC Electronics | 15 |
| Gem City Tuner | 9 |
| General Electric Co., Tube Div. | 57 |
| General Electric Co., | |
| TV Business Dept. | 5 |
| Heath Company | 3, 55 |
| Hickok Electrical Instrument Co. | 59 |
| Jensen Tools and Alloys | 9 |
| Lectrotech, Inc. | 22 |
| MTI | 52 |
| Mountain West Alarm Supply Co. | 58 |
| Non-Linear Systems, Inc. | 56 |
| Perma Power Div., | |
| Chamberlain Mfg. Corp. | 32 |
| Precision Tuner Service | Cover 2, 1 |
| Projector-Recorder Belt Co. | 53 |
| RCA Distributor & | |
| Special Products | 10-11, 18-19, 42-43 |
| Sencore, Inc. | 16-17 |
| Sperry Tech, Inc. | 2 |
| GTE Sylvania / ECG | |
| Consumer Renewal | 25 |
| Tektronix, Inc. | 21 |
| Trans Vista Electronics | 54 |
| Tuner Service Corporation | 7 |
| Ungar, Div. of Eldon | |
| Industries, Inc. | 12 |
| Western Instruments | 33 |
| Winegard Company | 27 |

Buss® Fuses Specialize Too!

in the protection of

C B

EQUIPMENT

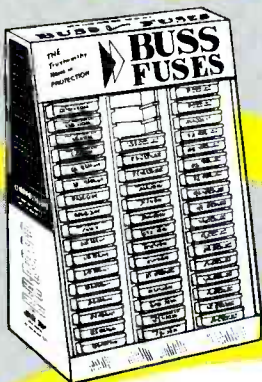
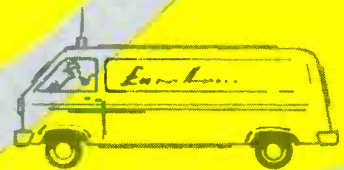

No. 240CB-3
Metal Display Stand

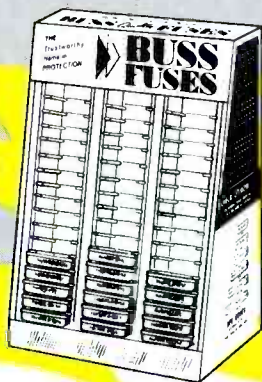

No. 80CB-1
Metal Display Stand

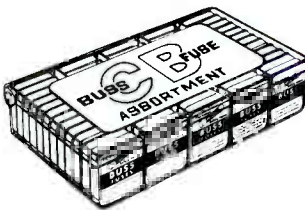

No. 240CB-4
Plastic Display Box

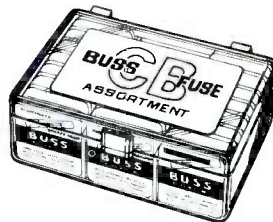

No. 80CB-2
Plastic Display Box

Now . . . four new BUSS fuse assortments exclusively designed with replacement fuses to service most Citizen Band Radios — offering a whole new area of opportunities for increased profits.

Two assortments contain 48 — 5 in metal boxes (240 fuses). BUSS No. 240CB-3 fuse assortment comes in a handy metal display stand. BUSS No. 240CB-4 fuse assortment is packed in a compact plastic display box.

In addition, there are two fuse assortments containing 16 — 5 in metal boxes (80 fuses). BUSS No. 80CB-1 fuse assortment packed in a metal display stand and BUSS No. 80CB-2 fuse assortment in a plastic display box.

Both BUSS fuse assortments contain a careful selection of the most popular fuses used in CB radios.

CB dealers can now have the fuses they need in a neat complete package to service all their customers fuse needs.

For full fuse assortment details, write for BUSS Bulletin CBA.



BUSSMANN MANUFACTURING
a McGraw-Edison Company Division
St. Louis, Missouri 63107



For More Details Circle (2) on Reply Card

FLUKE PROVES AN INEXPENSIVE, HANDHELD DMM CAN BE BUILT WITHOUT LEAVING EVERYTHING OUT.

Let's face it.

Before now, if you bought an inexpensive, handheld digital multimeter you didn't get much. In fact, you quickly discovered how they could build such a small DMM—they just left most everything out.

We knew that was no answer.

So we built the 8030A 3½-digit DMM. It's a small, portable, inexpensive, handheld DMM, but it performs like our benchtop units.

With one basic difference. The 8030A was designed, built and tested to a size and shape proven best for field service and laboratory technicians. There's a built-in hood that can be slipped forward to shade the readout in sunshine. It has rms capability. The best overload protection. Diode test. It weighs 2.5 pounds, and will take a beating without failing. Finally, we guaranteed accuracy specifications for one year.

And it only costs \$235*.

Nothing left out. Everything the technician needs in the field or the lab. At the right size. And a fantastic price.

| | |
|--------------------------|-------|
| True rms. | Fluke |
| 1-year accuracy specs. | Fluke |
| High voltage protection. | Fluke |
| Diode test. | Fluke |

A full line of accessories offering rf voltage, high current ac, high voltage dc, and temperature measurement probes. Fluke.

There's only one place to go for all the performance you need in a handheld DMM.

There are measurement functions in five selectable ranges for dc volts, ac volts (true rms), dc current, ac current (true rms), and resistance. DC voltage measurement is from 100 μ V to 1100V with basic accuracy of $\pm 0.1\%$, ac measurement is from 100 μ V to 750V rms with basic accuracy of $\pm 0.5\%$. DC and ac current is from 100 picoamps to 1.999 amps with basic dc accuracy of $\pm 0.35\%$ and basic ac accuracy of $\pm 1\%$. Resistance measurement is from 100 milliohms to 2 megohms with a basic ac-



"Fluke does the impossible again."

curacy of $\pm 0.4\%$.

We added true rms response for ac measurements. This means that the specified accuracy is still attainable when the measured waveform is distorted.

The 8030A is designed for hard use. There is extensive overload protection. It has been tested with transients up to

6000V peak across the input terminals.

Options include two battery operations. For constant portable use, a rechargeable NiCad for 8 hours operation free of line power, or for a less expensive approach, throw-away alkaline cells. Other options are probes for measurement of rf voltages, high current ac, high voltage dc and temperature. Carrying cases and test leads are also available.

And because the 8030A gives you so much in performance, let us remind you once more of the price.

Only \$235.

For the first handheld DMM that's small in size, small in price, but huge in performance.

For data out today, dial our toll-free hotline, 800-426-0361.

John Fluke Mfg. Co., Inc., P.O. Box 43210, Mountlake Terrace, WA 98043

Fluke (Nederland) B.V., P.O. Box 5053, Tilburg, The Netherlands.

Phone: (013) 673-973 Telex: 52237

*U.S. price only.

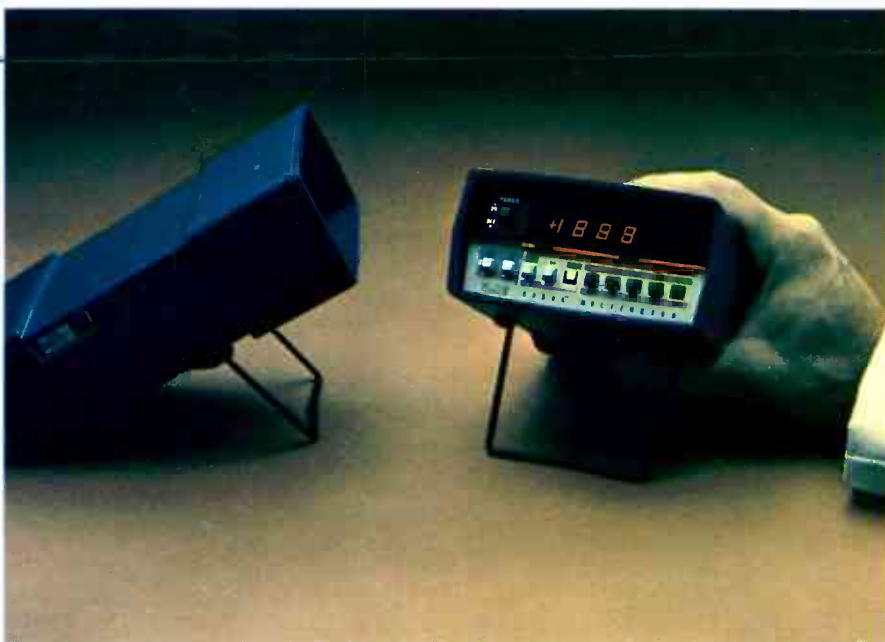

A NEW ADVANCE. 8030A DMM. 

For More Details Circle (3) on Reply Card